

CE 107406097

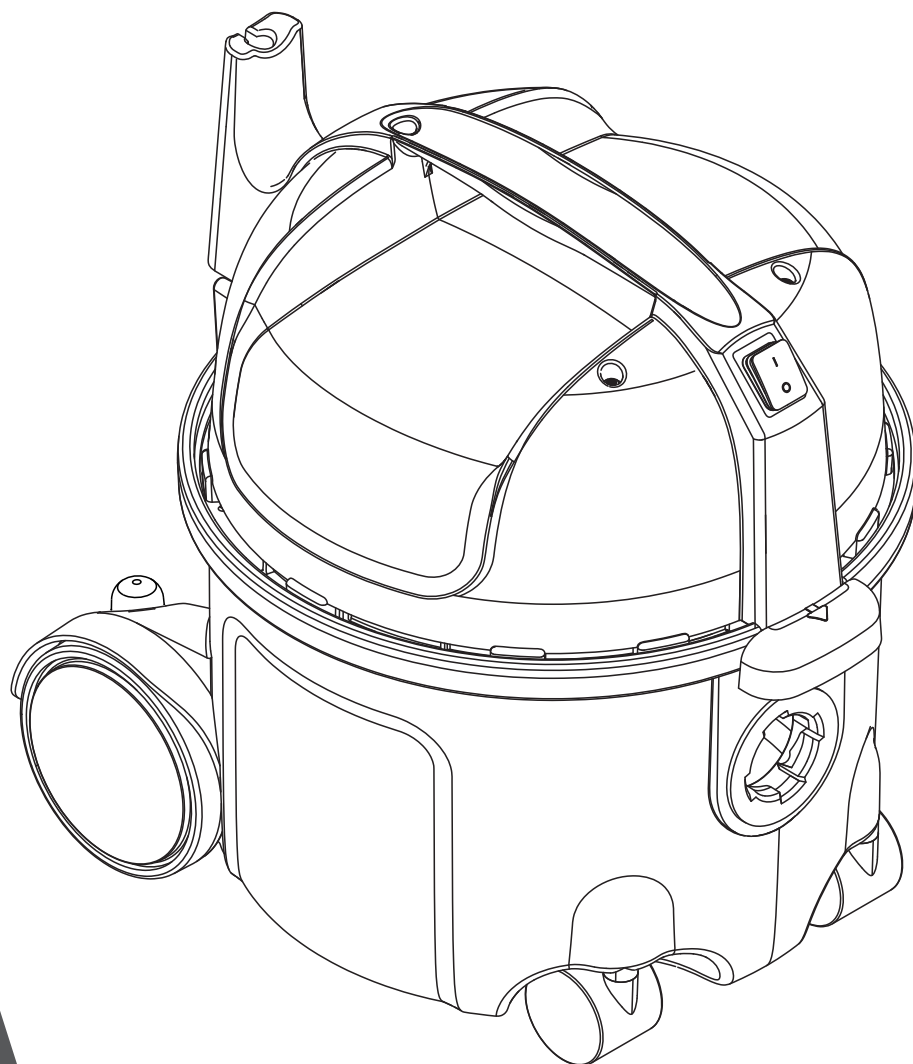

SPARE PARTS LIST

VP300 SERIES SPARE PARTS LIST



Table of Contents

VP300 / VC300 / GD 111

Summary (GD 111/VC300 / VP300)	3
Accessories	5
RECOMMENDED SPARE PARTS	7

Summary (GD 111/ VC300 / VP300)

19-01-2012

Part List ID
GD11102

VP300 / VC300 / GD 111

3

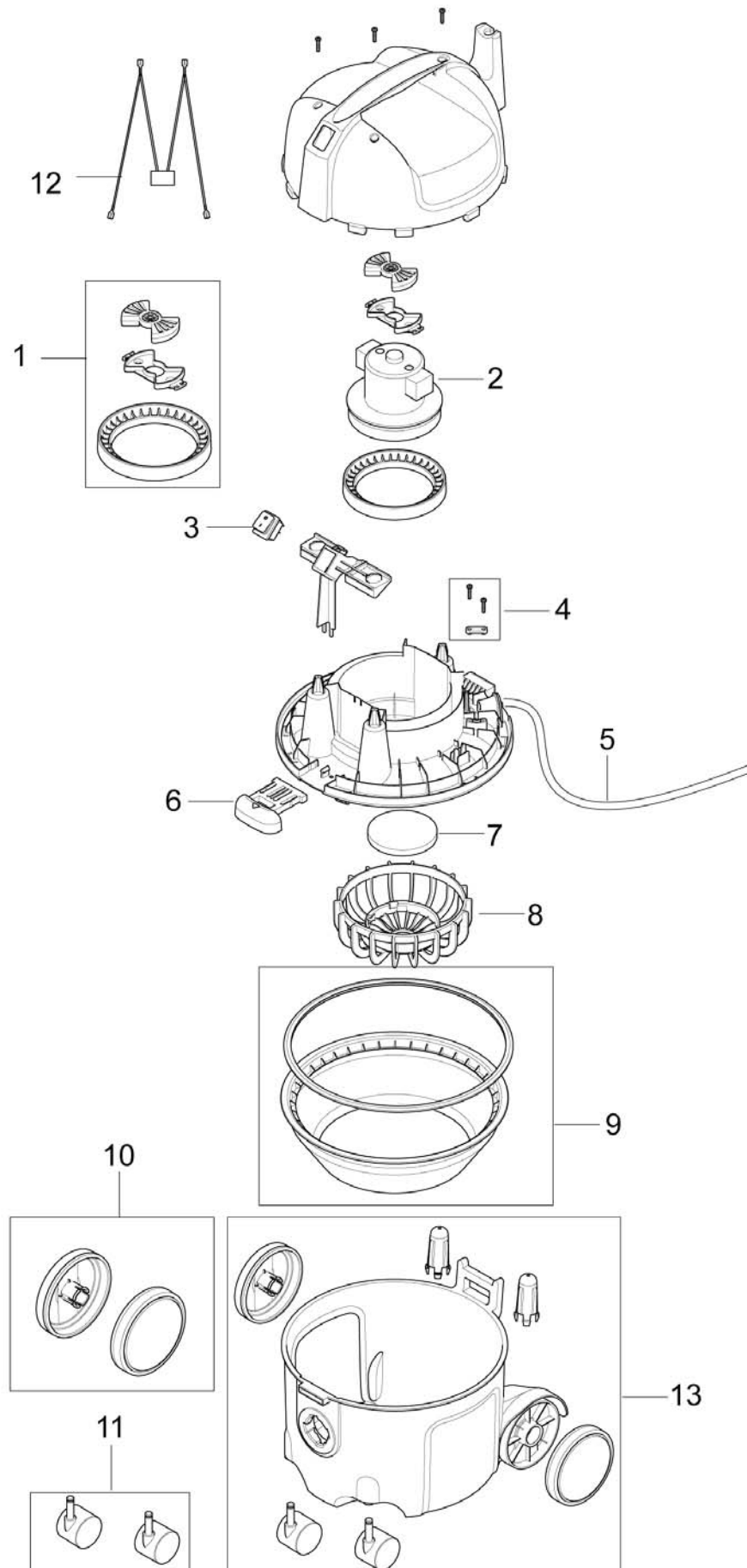

Summary (GD 111/ VC300 / VP300)

VP300/VC300/GD 111

19-01-2012

Part List ID

GD11102

4

Pos	Part no.	Qty	Description		EAN
0	147 1436 000	1	BOX GD111		5703887110
1	147 0660 500	1	MOTOR SUSPENSION KIT		7319519652
2	107402675	1	FAN UNIT 1200W TCO KIT	EU	5703887110
2	147 1428 500	1	FAN UNIT 230-240V 900W TCO	EU	7319519673
2	147 1429 500	1	FAN UNIT 110-120V 900W TCO	US	7319519673
2	147 1430 500	1	FAN UNIT 100V 900W TCO	JP	7319519673
3	140 9537 500	1	SWITCH TWO POLE 2 PCS		7319519639
4	140 6560 500	1	ANTI STRAIN CLIP		7319519640
5	107403731	1	CORDSET 15.5 MJP	JP	5703887113
5	140 3608 600	1	CORD SET 10.5M US/TW	US	7319519673
5	140 6643 580	1	CORD SET 10.5M UK	UK	7319519673
5	140 6676 570	1	COR SET A U NZ.BLACK 10M	AU	7319519673
5	140 6800 650	1	CORD SET 10M EU	EU	7319519673
5	147 0504 540	1	CORD SET 10.5M CHINA	CN	7319519673
6	147 1409 500	1	LATCH		7319519673
7	147 0670 500	1	FILTER MOTOR KIT		7319519651
8	147 0669 500	1	BASKET SACK FILTER		7319519651
9	147 1432 500	1	SACK FILTER CPL	Accessory	7319519673
10	140 8458 500	1	WHEEL REAR KIT		7319519632
11	140 6422 500	1	WHEELS LINK 50MM		7319519631
13	107406056	1	CONTAINER VP300		7319519640

Accessories

VP300/VC300/GD 111

19-01-2012

Part List ID
GD11106

5

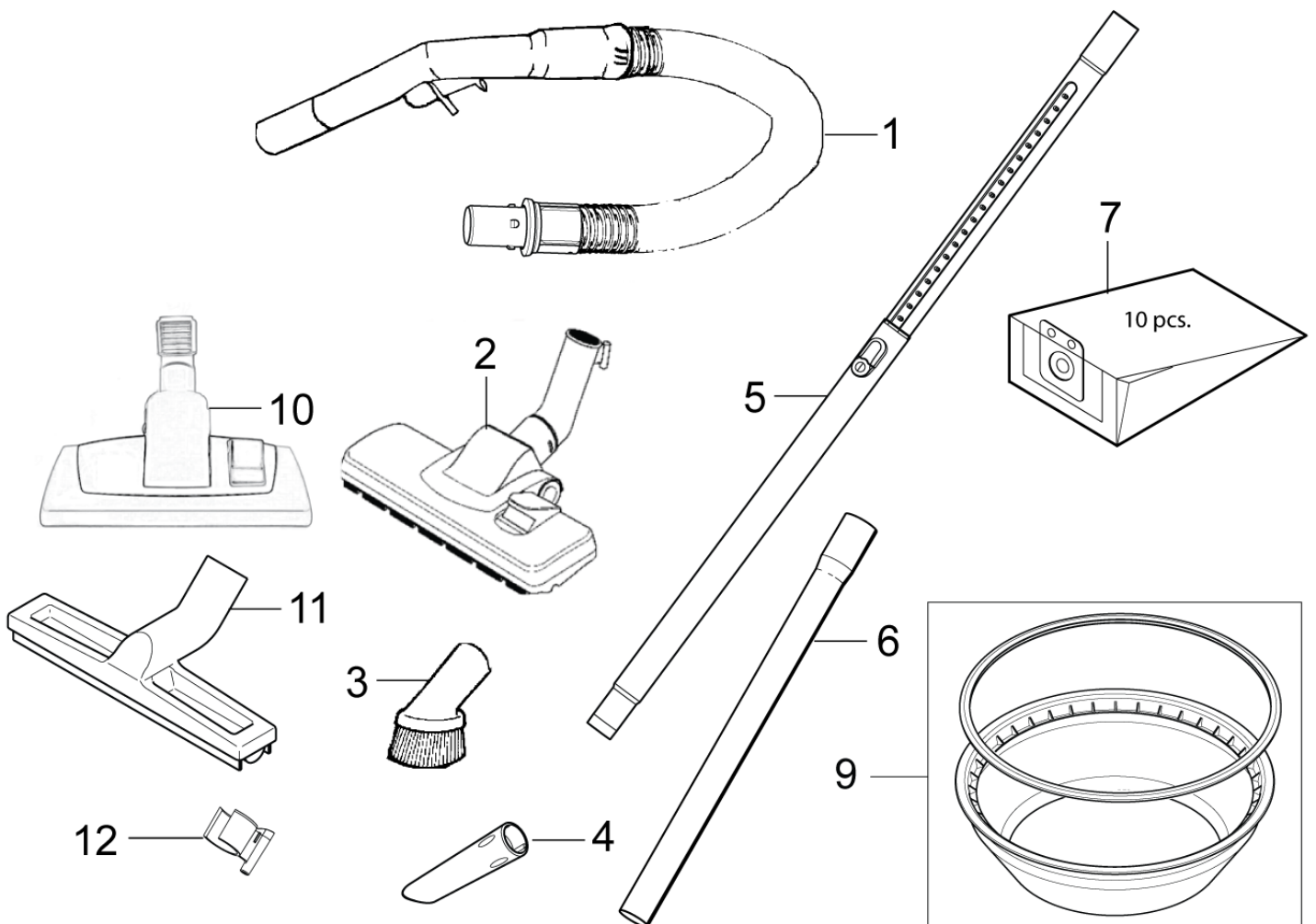

Accessories

VP300 / VC300 / GD 111

19-01-2012

Part List ID

GD11106

6

Pos	Part no.	Qty	Description	EAN
1	147 0765 500	1	HOSECPL BLACK	7319519651
2	107403122	1	COMBI NOZZLE D252 KIT	5703887113
2	107405141	1	SPAREPART COMBI NOZZLE VC300JP	5703887113
3	140 8244 500	1	BRUSH NOZZLE KIT	7319519658
4	147 0146 500	1	CREVICE NOZZLE D32 L153 BLACK	7319519647
5	011 8130 500	1	TELESCOPIC TUBE ALUMINIUM	7319519631
5	107403804	1	TELESCOPIC TUBE ACC.	5703887113
6	011 6431 500	2	EXTENSION TUBE ALUMINIUM	7319519631
6	140 8246 040	2	EXTENSION TUBE STEEL D32	7319519607
7	140 8618 000	1	DUST BAG 10L 10 PCS	7319519628
9	147 1432 500	1	SACK FILTER CPL	7319519673
10	140 8492 510	1	COMBI NOZZLE KIT	7319519636
11	140 6700 540	1	NOZZLE MULTI SURFACE 32 MM	7319519636
12	147 0585 500	1	PARKING CLIP SVART	7319519648

RECOMMENDED SPARE PARTS

VP300 / VC300 / GD 111

19-01-2012

Part List ID

GD11108

7

Pos	Part no.	Qty	Description	EAN
0	107402675	1	FAN UNIT 1200W TCO KIT	5703887110
0	140 6422 500	1	WHEELS LINK 50MM	7319519631
0	140 6560 500	1	ANTI STRAIN CLIP	7319519640
0	140 6643 580	1	CORD SET 10.5M UK	7319519673
0	140 3608 600	1	CORDSET 10.5M US/TW	7319519673
0	140 8458 500	1	WHEEL REAR KIT	7319519632
0	140 9537 500	1	SWITCH TWO POLE 2 PCS	7319519639
0	147 0660 500	1	MOTOR SUSPENSION KIT	7319519652
0	147 0669 500	1	BASKET SACK FILTER	7319519651
0	147 0670 500	1	FILTER MOTOR KIT	7319519651
0	147 1409 500	1	LATCH	7319519673
0	147 1429 500	1	FAN UNIT 110-120V 900W TCO	US 7319519673
0	147 1432 500	1	SACK FILTER CPL	7319519673



USA

Nilfisk-Advance Inc.
14600 21st Avenue North
Plymouth, MN 55447-3408
Tel.: (763) 745 3500
Fax : (763) 745 3718

Canada

Nilfisk-Advance Canada
240 Superior Boulevard Mississauga, ON L5T 2L2
Tel.: 905-564-1149
Fax: 905-564-1030