

CARPET • PRO

**OWNER'S
MANUAL**

High Performance Upright Vacuums

**CPU-250
Household**

**CPU-350
Commercial**



Save These Instructions

Index

Important Safety Instructions	2
Two-Wire Polarized Plug / Three-Wire Polarized Plug	3
Parts Identification.	4
Replacement Bags, Belts and Filters	4
How to Assemble and Operate the Vacuum	5
How to Adjust the Handle	5
How to Adjust the Height of the Nozzle.	6
Edge Cleaning Feature	6
Full Bag Indicator	6
How to Change the Vacuum Bag	6
How to Change the Filters	7
Cleaning with On-Board Tools	7
How to Replace the Vacuum Belt	8
Thermal Motor Protection	9
Troubleshooting	10
For Best Performance	10
Warranty	11

Customer's Record

The model and serial numbers of this product may be found on the back side of the unit. You should complete the enclosed warranty card and mail it back to us as soon as possible for your protection. Also, note the model and serial numbers of your unit in the spaces provided below, and retain this book as a permanent record of your purchase.

Model Number _____
Serial Number _____
Date Purchased _____
Retailer Purchased From _____

Your Carpet Pro vacuum cleaner is a product of high-quality materials and superior workmanship. We urge you to read these operating instructions carefully before you use this vacuum cleaner in order to obtain the full performance and satisfaction it can offer you.

Save These Instructions

Before you plug in your Carpet Pro vacuum cleaner, make sure the voltage indicated on the rating plate located on the back of the vacuum cleaner is the same as your local supply.

IMPORTANT SAFETY INSTRUCTIONS

READ ALL INSTRUCTIONS BEFORE USING THIS APPLIANCE.

This machine is not intended for use by persons (including children) with reduced physical, sensory or mental capabilities, or lack of experience and knowledge, unless they have been given supervision or instruction concerning use of the machine by a person responsible for their safety.

When using an electrical appliance, basic precautions should always be followed, including the following:

SAVE THESE INSTRUCTIONS.

WARNING! To reduce the risk of fire, electric shock, or injury:

1. Do not leave appliance unattended when plugged in. Unplug from outlet when not in use and before servicing.
2. **WARNING:** ELECTRIC SHOCK COULD OCCUR IF USED OUTDOORS OR ON WET SURFACES.
3. Do not allow to be used as a toy. Keep children and unauthorized persons away from the machine when in use.
4. Use only as described in this manual. Use only manufacturer's recommended attachments.
5. Do not use with damaged cord or plug. If appliance is not working as it should, has been dropped, damaged, left outdoors or dropped into water, return it to a service center.
6. **WARNING:** The replacement or repair of damaged wiring should only be performed by a qualified electrician or service engineer from the original distributor or authorized service agent.
7. Do not pull or carry by cord, use cord as a handle, close a door on cord or pull cord around sharp edges or corners. Do not run appliance over cord. Keep cord away from heated surfaces.
8. Do not unplug by pulling on cord. To unplug, grasp the plug, not the cord.
9. Do not handle plug or appliance with wet hands.
10. Turn off all controls before unplugging.
11. Do not put any object into openings. Do not use with any opening blocked; keep free of dust, lint, hair and anything that may reduce airflow.
12. Keep hair, loose clothing, fingers and all parts of body away from openings and moving parts.
13. Do not pick up anything that is burning or smoking, such as cigarettes, matches or hot ashes.
14. Do not use without vacuum bag and/or filters in place.
15. Use extra care when cleaning on stairs.
16. Do not use to pick up flammable or combustible liquids such as gasoline or use in areas where they may be present.
17. Do not attempt to service the unit while appliance is plugged in.
18. For grounded three-wire polarized plug models, connect to a properly grounded outlet only. See Polarization Instructions on page 3.

Two-Wire Polarized Plug

MODEL: CPU-250

This product is equipped with a polarized alternating current line plug (a plug having one blade wider than the other).

This plug will fit into the power outlet only one way. This is a safety feature. If you are unable to insert the plug fully into the outlet, try reversing the plug. If the plug should still fail to fit, contact an electrician to replace the obsolete outlet. Do not defeat the safety purpose of the polarized plug.

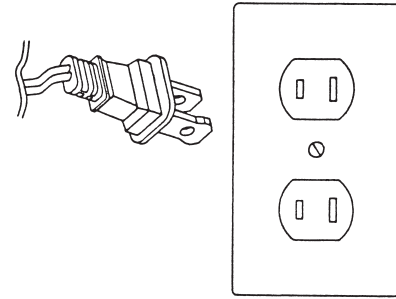

Three-Wire Polarized Cord

MODEL: CPU-350

This appliance must be grounded. If it should malfunction or break down, grounding provides a path of least resistance for electric current to reduce the risk of electric shock. This appliance is equipped with a cord having an equipment-grounding conductor and grounding plug. The plug must be plugged into an appropriate outlet that is properly installed and grounded in accordance with all local codes and ordinances.

This appliance is for use on a nominal 120 volt circuit and has a grounding attachment plug that looks like the plug illustrated in Fig. 1. Make sure appliance is connected to an outlet having the same configuration as the plug. No adapter should be used with this appliance.

WARNING: Improper connection of the equipment-grounding conductor can result in a risk of electric shock. Check with a qualified electrician or service person if you are in doubt as to whether the outlet is properly grounded. Do not modify the plug provided with the appliance. If it will not fit the outlet, have a proper outlet installed by a qualified electrician.

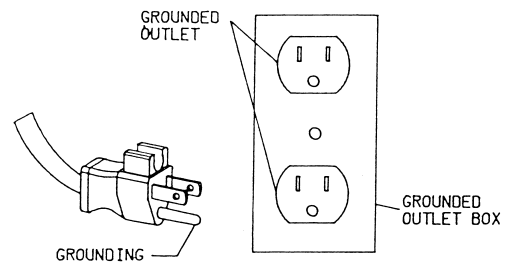

Fig. 1

State of California Proposition 65 Warnings:

WARNING: This product contains one or more chemicals known to the State of California to cause cancer.

WARNING: This product contains one or more chemicals known to the State of California to cause birth defects or other reproductive harm.

Parts Identification

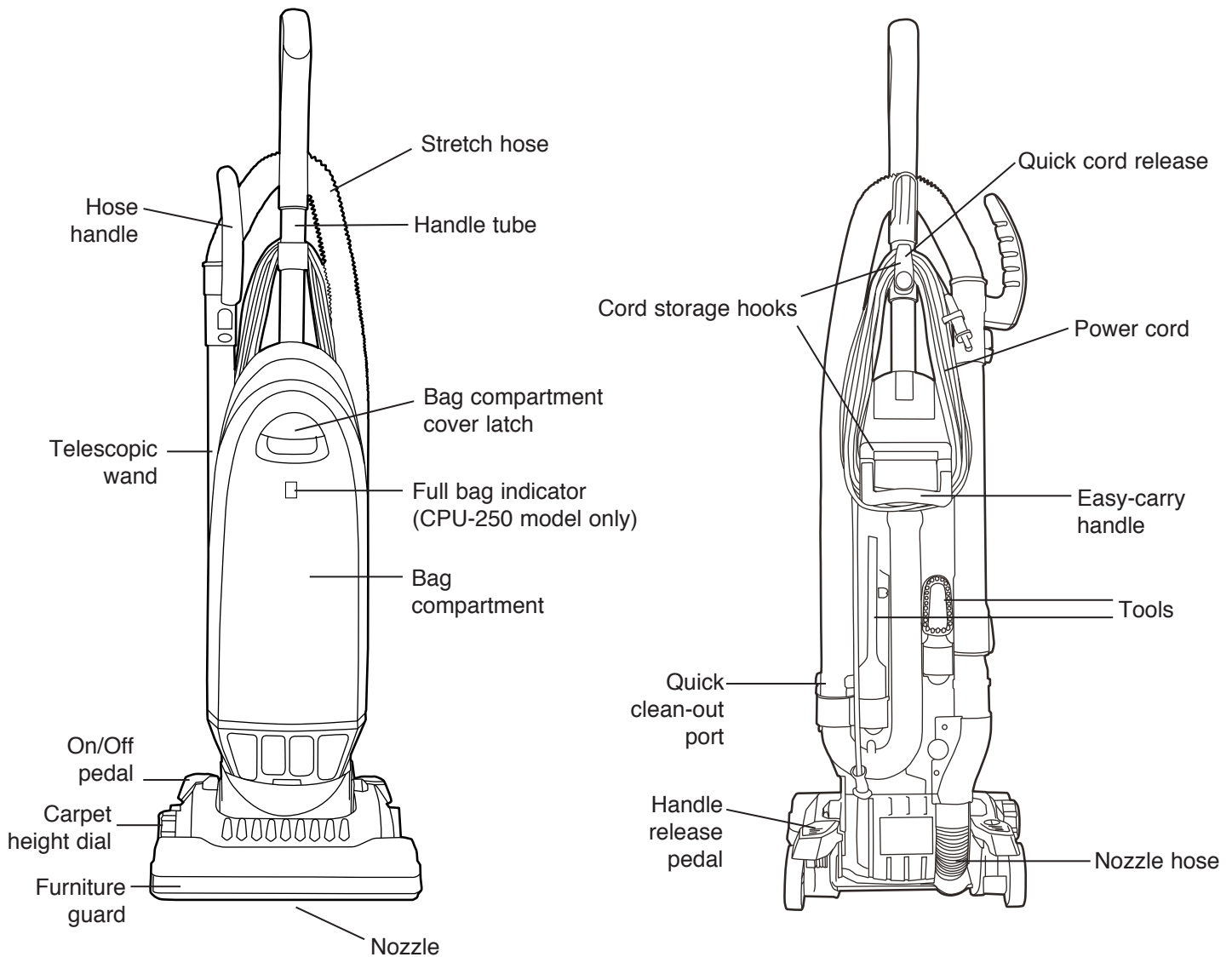

Replacement Bags, Belts and Filters

- Genuine Carpet Pro Paper Bags
Part # CPP-3, 3 per package
- Genuine Carpet Pro Belt Set
Part # CPU250-B2

- Genuine Carpet Pro Filter Set
Part # CPU250-F

How to Assemble and Operate the Vacuum

How to Attach the Handle to the Vacuum Cleaner

The vacuum and the handle are packed separately.

1. After first removing the handle screw, slide the handle into the slot on top of the vacuum cleaner.
2. Line up the small hole on the handle with the small hole on the vacuum cleaner and insert the screw. Make sure the screw is tightened securely (Fig. 1).
3. Turn the upper cord storage hook to the upright position and wind the power cord around the cord storage hooks when storing the vacuum cleaner (Fig. 2).

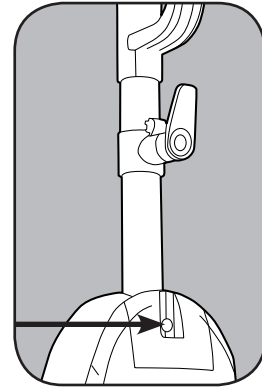

Fig. 1

How to Release the Power Cord

1. The upper cord storage hook has a quick-release action. To release the cord, rotate the hook downward and the cord will drop off the handle for immediate use (Fig. 2).
2. Return the hook to the upright position before attempting to rewind the cord.

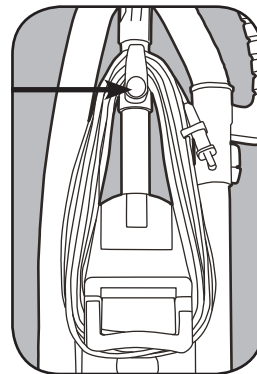

Fig. 2

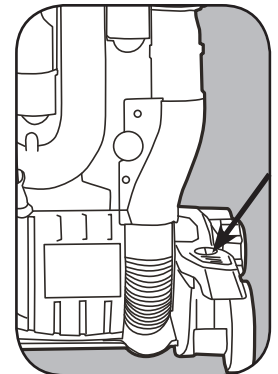

Fig. 3

On/Off Pedal

1. To turn the vacuum on, push the power pedal on the right side of the vacuum nozzle from the user's perspective (Fig. 3).
2. To turn the vacuum off, push the pedal again.

How to Adjust the Handle

The handle on this vacuum cleaner can be set to one of three positions – upright, middle or low.

How to Adjust the Handle

1. To release the handle, step on the handle release pedal on the left side of the vacuum cleaner nozzle from the user's perspective and pull back the handle (Fig. 1).
2. Upright position – for storage or when cleaning tools are used (Fig. 2). Handle locks in this position.
3. Middle position – for normal cleaning (Fig. 3).
4. Low position – for cleaning under furniture* (Fig. 4).

*Once in the middle position, step on the handle release pedal again and lower the handle to place the vacuum in the low position.

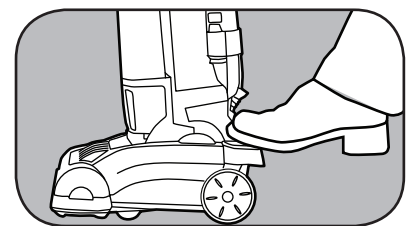

Fig. 1

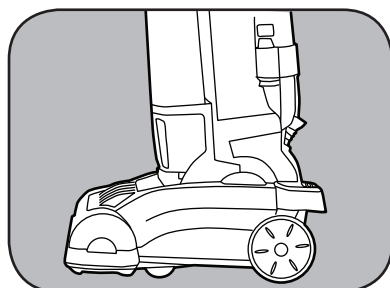

Fig. 2

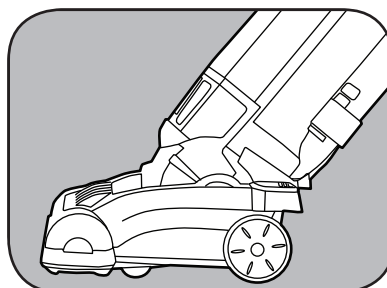

Fig. 3

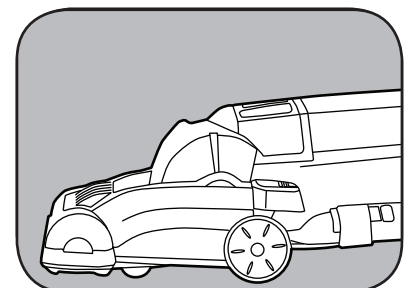
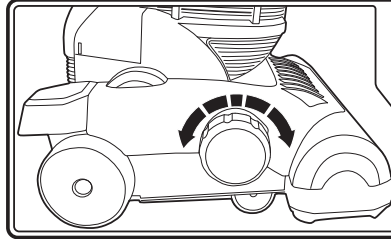

Fig. 4

How to Adjust the Height of the Nozzle

How to Adjust the Height of the Nozzle

1. When the vacuum handle is reclined, rotate the height adjustment dial to the type of floor being vacuumed (Fig. 1).



Settings for the height adjustment dial				
MAX Shag/ Frieze Carpet	X-HIGH Plush Carpet	HIGH Medium Pile Carpet	AUTO General Setting	LOW Low Pile Carpet & Bare Floors

Fig. 1

Edge Cleaning Feature

The edge cleaning feature provides improved cleaning near walls and stationary furniture. For maximum edge cleaning, position the right side of the vacuum from the user's perspective near walls or stationary furniture.

Full Bag Indicator

Full Bag Indicator (CPU-250 model only)

The full bag indicator is designed to show when the bag is full or when there is a clog in the vacuum.

- If the red indicator appears:
 - Change the vacuum bag
 - If the vacuum bag is not full, but the full bag indicator is red, check the hose for a clog.
- When cleaning with a tool (dusting brush or crevice tool), the red indicator may appear. In this case, continue cleaning.

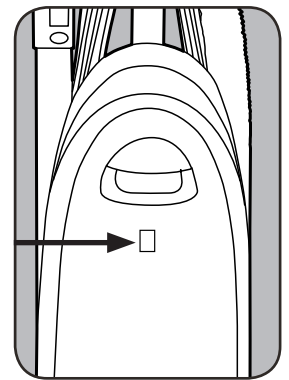

Fig. 1

How to Change the Vacuum Bag

Always operate the vacuum cleaner with a vacuum bag installed. Bags should be changed when they are 2/3 full.

How to Change the Vacuum Bag

1. Unplug the vacuum cleaner. Remove the bag compartment cover (Fig. 1).
2. Remove the bag from the bag holder by grasping the sides of the bag collar and pulling straight off. Attach a new vacuum bag by pushing the collar onto the inlet (Fig. 2).
3. Pull out the bottom corners of the new vacuum bag to expand the bag capacity (Fig. 3).
4. Reinsert the tab on the end of the bag compartment cover into the groove on the bag compartment housing. Press the bag compartment cover into place, closing it tightly.

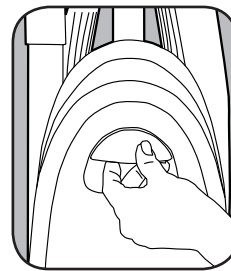

Fig. 1

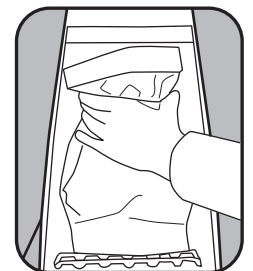

Fig. 2

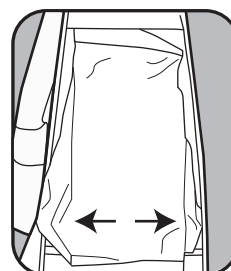

Fig. 3

How to Change the Filters

Your vacuum cleaner is equipped with a secondary filter and a foam filter. These filters capture fine dust particles and protect the motor from dirt. Accumulated dirt in the bag compartment will be collected on the filters and may restrict motor performance. It is important to change the filters regularly — approximately once a year or as needed.

How to Change the Secondary Filter

1. Unplug the vacuum cleaner. Remove the bag compartment cover and remove the vacuum bag.
2. Remove the secondary filter by sliding it out from under the bag supporter (Fig. 1).
3. Insert a new filter, replace the bag and bag compartment cover.

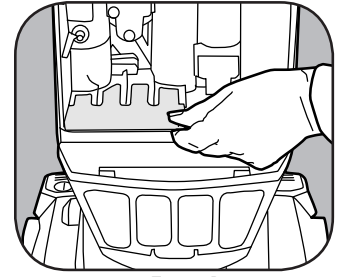

Fig. 1

How to Change the Foam Filter

1. Unplug the vacuum cleaner. Remove the filter cover below the dust compartment cover (Fig. 2).
2. Remove the filter from the front of the vacuum (Fig. 3).
3. Insert a new filter and replace the filter cover.

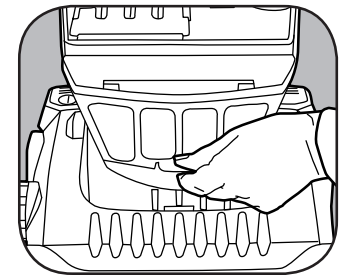

Fig. 2

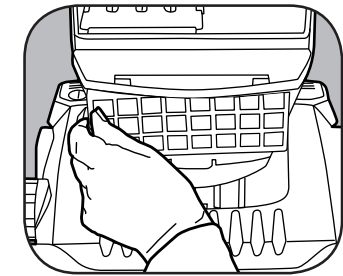

Fig. 3

Cleaning with On-Board Tools

Your vacuum cleaner is equipped with on-board cleaning tools, including a telescopic wand, stretch hose, dusting brush and a crevice tool.

1. To use the cleaning tools, lift the hose handle straight up from the vacuum (Fig. 1).
2. Extend the wand by pulling the button back and pulling the smaller wand out of the larger wand (Fig. 2).
3. Attach any of the on-board tools to the end of the wand, or if you do not need the wand, any tool can be connected directly onto the hose handle.

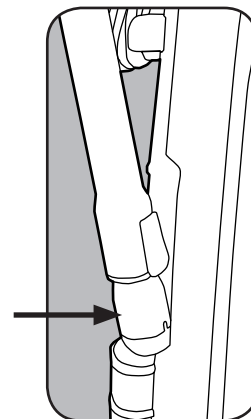

Fig. 1

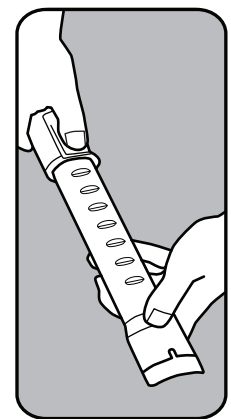

Fig. 2

How to Replace the Vacuum Belt

CAUTION: First unplug the vacuum cleaner.

How to Remove the Bottom Plate

1. Place the vacuum cleaner in the lowest position by stepping on the handle release pedal (see "How to Adjust the Handle" on page 5). Turn the vacuum over on a flat surface, exposing the bottom plate.
2. Remove the five screws holding the L-shaped bottom plate in place (Fig. 1).
3. Remove the bottom plate.

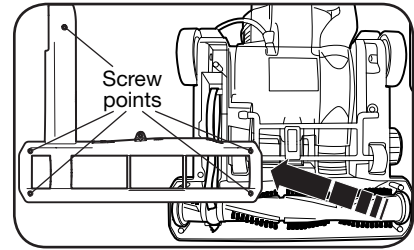

Fig. 1

How to Replace the Belt

1. Turn over the unit and remove the bottom plate as described above.
2. Lift out the brushroll and remove the old belt (Fig. 2).
3. Loop the new belt around the drive shaft (Fig. 3) and the raised ring between the bristles on the brushroll (Fig. 4).
4. Pull the brushroll forward (against the pull of the belt) and reinsert the ends back into the nozzle (Fig. 5) making sure to line up the end opposite the belt so the flat edges slide down properly.
5. Turn the brushroll by hand, making sure the belt is not twisted and all rotating parts move smoothly.
6. Replace the bottom plate and the five screws.

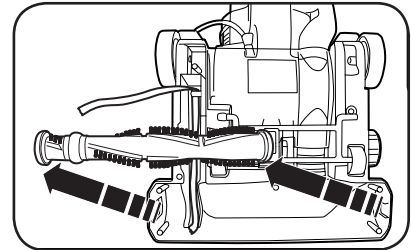

Fig. 2

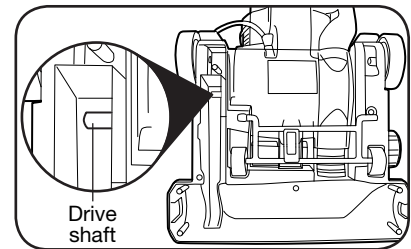

Fig. 3

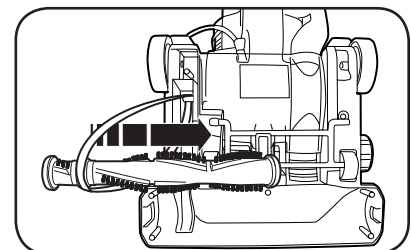

Fig. 4

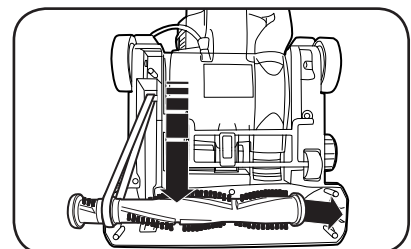

Fig. 5

Thermal Motor Protection

Your vacuum cleaner is equipped with a thermal protector designed to protect your vacuum cleaner from overheating due to restricted airflow (i.e. clogged hose). Should this situation occur, the thermal protector will automatically shut off the motor to prevent damage.

How to Reset the Thermal Protector

1. Unplug the vacuum cleaner.
2. Allow the vacuum cleaner to cool at least 30 minutes.
3. Check for blockages, change the vacuum bag and clean or replace the filters.
4. Plug in the vacuum cleaner and begin using.

Please contact your Authorized Carpet Pro service center with any questions.

Troubleshooting

Problem	Check Point	Possible Solution
Suction power is weak.	<ul style="list-style-type: none">• Vacuum bag• Wand or hose• Filters	<ul style="list-style-type: none">• If the vacuum bag is 2/3 full, replace it.• If clogged or blocked, remove the object.• Clean or replace filters.
The vacuum does not work.	<ul style="list-style-type: none">• Power cord	Insert the power plug firmly into an electrical outlet.
Sudden loss of power.	<ul style="list-style-type: none">• Thermal reset	Turn off vacuum and unplug from electrical outlet. Let vacuum cool down for at least 30 minutes before turning back on. Check for clogs. Replace vacuum bag.
Dirt and debris are blowing through exhaust vent.	<ul style="list-style-type: none">• Filters	Make sure filters are clean, dry and installed correctly.
All other service should be performed by an Authorized Carpet Pro Service Center.		

For Best Performance

- Keep machine and all accessories clean and in good operating condition.
- Replace the bag when it is 2/3 full.
- Replace the filters once a year or as needed.
- Always use genuine Carpet Pro filters and parts, as use of other products may result in poor cleaning or filtration performance. Carpet Pro filtration products are designed for maximum performance.
- Store machine carefully in a dry area.
- For optimum cleaning performance and safety, follow your owner's manual.

Warranty

What Is Covered:

This warranty covers any defects in material and workmanship in your new Carpet Pro vacuum.

How Long Coverage Lasts:

Warranty coverage for the Carpet Pro vacuum lasts one year. Household models used commercially are only warranted for 90 days.

What Is Not Covered:

- Damage to the vacuum that occurs from neglect, abuse, alterations, accident, misuse or improper maintenance.
- Normal replacement items: disposable vacuum bags, disposable filters and belts.

What Carpet Pro Will Do:

This warranty provides, at no cost to you, all labor and parts to keep this vacuum in proper operating condition during the warranted period.

How to Get Service:

Warranty service can only be obtained by presenting the vacuum to a Carpet Pro Service Center. A proof-of-purchase and product serial number will be required before service is rendered.

THIS WARRANTY IS EXCLUSIVE AND IN LIEU OF ANY AND ALL OTHER WARRANTIES WHETHER WRITTEN, ORAL, EXPRESSED OR IMPLIED, (INCLUDING ANY WARRANTY OF MERCHANTABILITY OR FITNESS FOR A PARTICULAR PURPOSE). THIS WARRANTY DISCLAIMS LIABILITY FOR INCIDENTAL OR CONSEQUENTIAL DAMAGES.

How State Law Applies:

This warranty gives you specific legal rights, and you may also have other rights that vary from state to state.

C A R P E T • P R O

Carpet Pro Vacuum Cleaners
PO Box 730
Fenton, MO 63026