

Safety Precautions



WARNING: Please read precautions thoroughly before operation. Meet all applicable local codes and regulations.

THANK YOU FOR YOUR INTEREST IN OUR PRODUCTS

Please use this equipment carefully and observe all warnings and cautions.

WEAR

protective clothing and eyewear when dispensing chemicals or other materials or when working in the vicinity of all chemicals, filling or emptying equipment, or performing maintenance.

observe safety and handling instructions of the chemical manufacturer.

direct discharge away from you or other persons or into approved containers.

ALWAYS

dispense cleaners and chemicals in accordance with manufacturer's instructions. Exercise CAUTION when maintaining your equipment.

reassemble equipment according to instruction procedures. Be sure all components are firmly screwed or latched into position.

KEEP

equipment clean to maintain proper operation.

ATTACH

only to water tap outlets (25 PSI Minimum, 85 PSI Maximum and Maximum water temperature 120° F).

NOTE

if the unit is used to fill a sink, or the discharge hose can be placed into a sink, the unit must mounted be so the bottom of the cabinet is above the overflow rim of the sink.

if the supply cord is damaged, it must be replaced by the manufacturer, its service agent or similarly qualified persons in order to avoid a hazard.



CAUTION: Before an installation takes place it is advisable to complete a site survey to ensure the DMx Warewash Dispenser can be installed in a position that meets all the stated requirements.



CAUTION: Do not install unit in potentially explosive environment where flammable gas, steam, fog or dust can form an explosive combination with air.



WARNING: Electrical installation should be completed by a qualified electrician. All local and national electrical regulations are to be observed.

introduction

Package Contents

DMx Warewash Dispenser (P/N varies by model)

Mounting Kit (HYD13-06647-00) Mounting Bracket, Wall Anchors and Screws

Accessory Kit:

2-Product (HYD90099996) Detergent and Rinse Injection Fittings. and Basic Conductivity Probe

3-Product (HYD90099997) Detergent, Rinse and Sanitizer Injection Fittings. and Basic Conductivity Probe

Product Options:

- Rinse Temperature Sensor Kit
- Temperature Compensated Conductivity Probe Kit
- Inductive Probe Kit (Temperature Compensated)
- Pump tubing Kit (Chemical pick-up tubing, with stiffeners)

DMx 2-Product
& 3-Product
Warewash
Dispensers

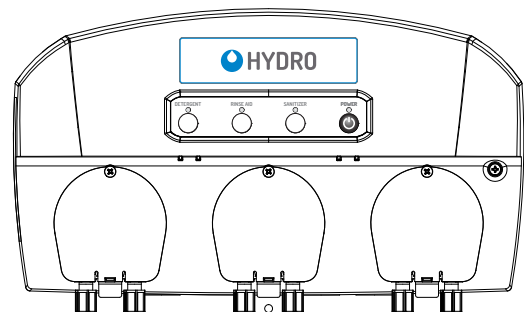
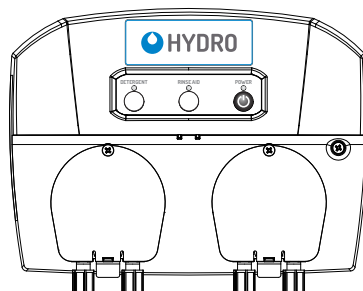

introduction (continued)

Product Diagram

1. Main Cabinet - Front
2. Branding Label Area
3. Dispenser Control Pad
4. Solids Solenoid
5. Peristaltic Liquid Pump
6. Main Cabinet Cover
7. Main Cabinet - Rear
8. Locking Screw

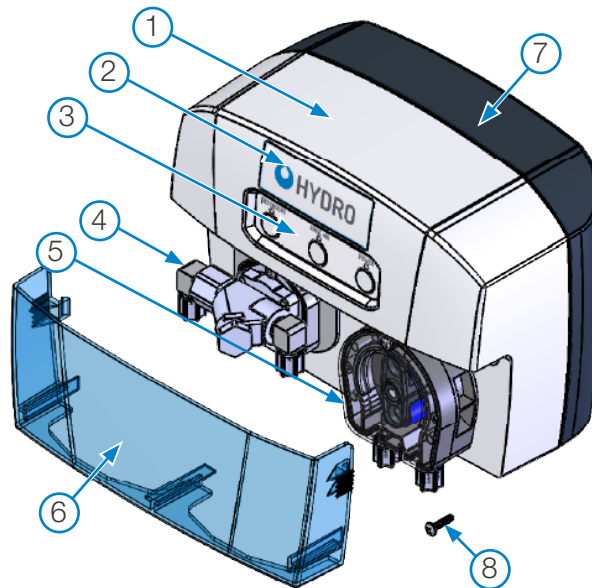

General Specifications

Category	Specification		
Electrical			
Input Voltage	100-230 VAC at 50/60 Hz up to 1.0 Amps maximum (Class I)		
Power Usage	24W maximum		
Detergent Signal Input	24-250VAC at 50/60Hz up to 20mA or 24VDC up to 20mA		
Rinse Signal Input	24-250VAC at 50/60Hz up to 20mA or 24VDC up to 20mA		
Weights and Dimensions	2-Product Models	3-Product Models	
Weight:	Unboxed	Nominal: 1.8 Kg (4.0 lbs)	Nominal: 2.5 Kg (5.5 lbs)
	Boxed	Nominal: 5 Kg (11 lbs)	Nominal: 5.9 Kg (13 lbs)
Dimensions:	Unboxed	247 mm Wide x 185 mm High x 134 mm Deep 9.7 in Wide x 7.3 in High x 5.3 in Deep	361 mm Wide x 201 mm High x 134 mm Deep 14.2 in Wide x 7.9 in High x 5.3 in Deep
	Boxed	558.8 mm Wide x 279.4 mm High x 279.4 mm Deep 22 in Wide x 11 in High x 11 in Deep	558.8 mm Wide x 279.4 mm High x 279.4 mm Deep 22 in Wide x 11 in High x 11 in Deep
Operating Environment			
Ambient Temperature	10°C minimum to 50°C maximum (50°F minimum to 120°F maximum)		
Humidity	95% relative humidity maximum		
Indoor Installation	Indoor Use Only. Must not be installed outdoors.		
Pump Performance *	Peristaltic Pumps (Flow rates indicated below are nominal.)		
* Always test with actual chemical, at installation, for accurate flow rate.	Detergent Pump: 355 ml/min (12 oz/min) Rinse/Sanitizer Pump: 15 ml/min (0.5 oz/min) Maximum (Adjustable)		
Inlet Water *	Water Temperature	Water Pressure	
* For Solenoid equipped models only.	5°C minimum to 60°C maximum (40°F minimum to 140°F maximum)	Min: 2 Bar / 0.2 MPa / 30 PSI Max: 6 Bar / 0.6 MPa / 90 PSI	
Regulatory Approvals	UL 60730-1:2016Ed.5, CSA E60730-1:2015 Ed.5, IEC 60730-1:2013Ed.5+C1 Automatic Electrical Controls - Part 1: General Requirements CENELEC EN 61326-1*CEI 2013/01/01 Electrical Equipment for Measurement, Control and Laboratory Use – EMC Requirements - Part 1: General Requirements IEC61000-4-3 Radiated RF Susceptibility -and- IEC61000-4-6 Conducted RF Susceptibility		
Part 15 - Class A digital device or peripheral	This equipment has been tested and found to comply with the limits for a Class A digital device, pursuant to part 15 of the FCC Rules. These limits are designed to provide reasonable protection against harmful interference when the equipment is operated in a commercial environment. This equipment generates, uses, and can radiate radio frequency energy and, if not installed and used in accordance with the instruction manual, may cause harmful interference to radio communications. Operation of this equipment in a residential area is likely to cause harmful interference in which case the user will be required to correct the interference at his own expense. Changes or modifications not expressly approved by the party responsible for compliance could void the user's authority to operate the equipment.		

introduction (continued)

Description

The DMx is a versatile, scalable warewash dispenser, designed to accurately and reliably dispense solid or liquid detergents, rinse aid or sanitizer in commercial kitchens. It functions with most styles of dish machines and is available with numerous optional upgrades to enhance its functionality. The DMx is compatible with Hydro Connect (Hydro's IoT platform) and features intuitive configuration and comprehensive reporting through the Hydro Connect Mobile Application.

Intended Use

- The DMx Warewash Dispenser is intended for use in industrial applications and is not suitable for household use.
- The product must only be used for dispensing warewash detergents, rinse aids, and sanitizers.
- The manufacturer waives any responsibility arising from incorrect usage or transportation.

installation

Site Survey and Installation Requirements

- Unit is to be installed by a trained technician; all local and national water regulations are to be observed.
- Unit must be installed indoors, in an area that does not expose the unit to excessive temperature changes, direct sunlight, frost or precipitation of any kind.
- The area must be free of high levels of Electromagnetic Interference (EMI).
- Ensure the unit will be mounted in an accessible location, above the height of the dishwasher's detergent inlet.
- The dispenser should be mounted close to the product containers--ideally, within 2 meters (6.6 feet).
- The dispenser should be mounted close enough to the dish machine electrical control panel to allow dispenser wiring without use of an external junction box (not provided) wherever possible. Wire harness is 3.5 meters (11.5 feet).
- Installer must ensure the suitability of the wall or mounting substrate, which should be flat and perpendicular to the floor.
- Unit location should be well lit for any maintenance, and should be free of high levels of dust particulates.
- Scheduled maintenance should be carried out on the unit at least once per year.
- It is a legal requirement that all water supply hose sets must be compliant with IEC 61770.
- Ensure the chemicals being used are compatible with supplied tubing.

Mounting Bracket

1. Using the mounting bracket as a template, mark holes to drill into mounting surface.
2. For sheet metal mounting with screws and nuts, drill 6 mm (1/4") holes. For wall anchors, drill 8 mm (5/16 inch) holes.
3. Insert the two wall anchors into the drilled holes, pushing them flush to the wall.
4. Secure the bracket to the wall with the two screws and washers, using a #2 Phillips screwdriver or equivalent.
5. Hang unit on bracket.

installation (continued)

Conductivity Probe

The Conductivity probe senses the detergent concentration and measures the tank temperature if the optional temperature compensated probe has been ordered. Correct probe placement is critical for accurate detergent concentration control.

Always use the new probe provided with the dispenser. When choosing a mounting location, make sure that the probe will be completely immersed in wash tank solution, in an area that has a good flow of solution and close to the product entry point.

Many dish machines will have knockouts provided for probe installation and/or will have existing probes.

Previously punched holes may be suitable, but always confirm that the probe will be immersed in the wash tank solution before installing.

The following steps describe probe installation.

- 1) Cut a 22mm or 7/8" hole using a suitable hole punch or cutter and ensure that all sharp edges, cutting debris and burrs are removed.
- 2) Remove probe retaining nut, plastic washer and one of the rubber washers.
- 3) Insert the probe into the hole and re-assemble the rubber washer, plastic washer and retaining nut back onto the probe from inside the dish tank.
- 4) Tighten the retaining nut by hand, enough to prevent leaking.

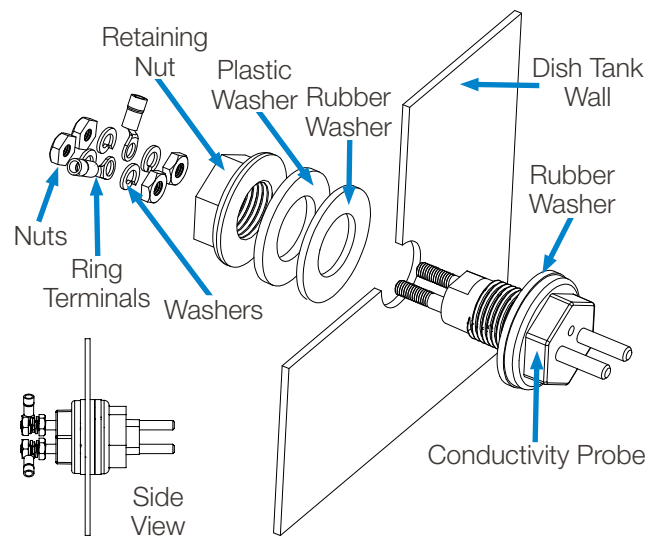

Detergent Bulkhead Fitting

Correct placement of the detergent bulkhead fitting is critical for accurate detergent concentration control. Ensure that the detergent bulkhead fitting is:

- Above the water line in the tank.
- Close to the conductivity probe location.
- Discharging detergent directly into the wash tank and not on top of any shelf areas or obstacles that could prevent detergent from falling directly into the wash tank.

- 1) If no suitable hole is available, cut a 22mm or 7/8" hole using a suitable hole punch or cutter and ensure that all sharp edges, cutting debris and burrs are removed.
- 2) Remove the detergent bulkhead fitting retaining nut
- 3) From outside the machine, insert the detergent bulkhead fitting (with rubber gasket) into hole.
- 4) From inside the machine, install the second rubber gasket, plastic washer and plastic retaining nut.
- 5) Tighten finger-tight, then snug using wrench.

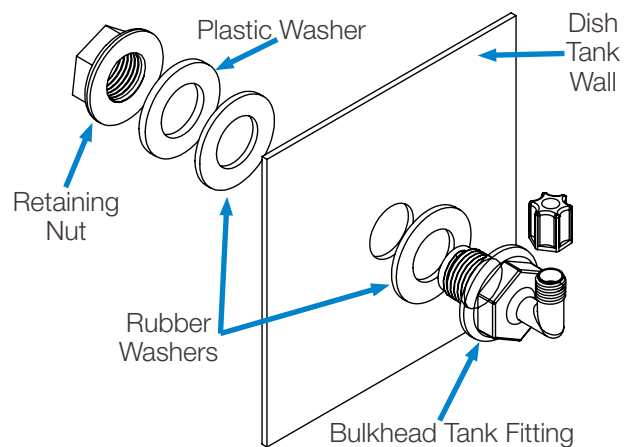

installation (continued)

Rinse Pump Injection Fitting



NOTE: You must install the rinse injection fitting downstream of any rinse solenoid.



CAUTION: Ensure there are no kinks or sharp bends in the tubing between the pump and the rinse injection fitting, to ensure free flow of rinse chemical into the rinse water.



CAUTION: Choose a location for the rinse injection fitting that allows the installation to comply with local and national plumbing regulations, ensuring there is no backflow of rinse chemicals into a potable or municipal water supply.

Installation Method 1:

- 1) Most machines will have a 1/8" NPT inlet blanked off on the rinse water manifold
- 2) Remove the blanking cover and install the rinse pump injection fitting. Use thread sealant to ensure a leak free assembly.

Installation Method 2:

- 1) Drill a 5.5mm (7/32") hole in the location at which you have decided to install the rinse pump injection fitting.
- 2) Cut threads into the hole using a 1/8" NPT tap, ensuring that all sharp edges, cutting debris and burrs are removed.
- 3) Install the rinse pump injection fitting. Use thread sealant to ensure a leak free assembly.

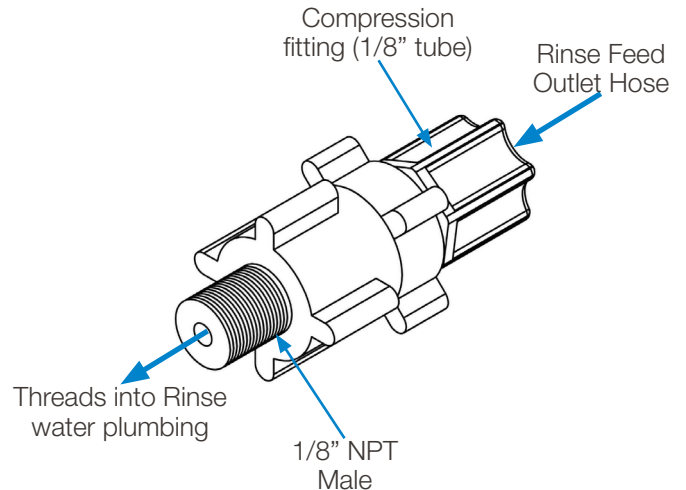

Chemical Supply and Discharge Tubing



NOTE: Ensure there are no kinks or sharp bends in the discharge hose, between the unit and the discharge fitting, to ensure free flow of each product to its intended location.

NOTE: The installation below is described using Hydro's optional pump tubing kit.

Inlet Tubing

- 1) Using the 1/4" tubing, cut the tube to the correct length (keeping enough for the outlet tubing). Route the tubing through the tube stiffener and connect the strainer onto the end of the tube that will be placed into the chemical container.
- 2) Install the tubing with the strainer and tube stiffener into the chemical container, ensuring that any entry hole produced in the container is suitable as not to allow particulates or any contamination to enter the container.
- 3) Connect the inlet tubing to the inlet on the corresponding pump. Loosen the compression fitting by one turn, then push the tube into the fitting and tighten.

Outlet Tubing

- 1) Before cutting, measure the length needed to reach the location where you will be dispensing product, including extra length for routing the tubing out of the way.
- 2) Install tubing into the outlet of the pump and the bulkhead fitting by loosening the compression nuts by one turn, then push the tube into the fittings and tighten.

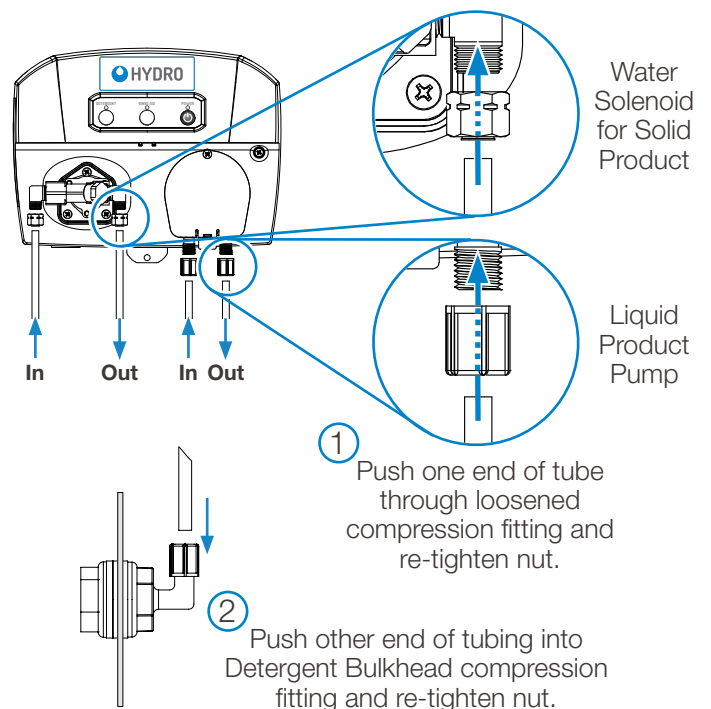

installation (continued)

Electrical Installation



WARNING: Electrical installation and maintenance should be completed by a qualified electrician. All local and national electrical regulations are to be observed.



CAUTION: All electrical connections (excluding the conductivity probe) are to be made either in the dish machine control circuit panel or in a suitable, external junction box.

Where applicable, all cable entries into new equipment must be made with a water tight conduit fitting or gland, meeting the appropriate local and national regulations.

Ensure all wiring is routed neatly and safely between appliances, as not to create any trip hazards that could result in injury, or damage to the equipment or wiring.

Electrical Connections

NOTE: Two-pump system shown, with Basic Conductivity Probe.

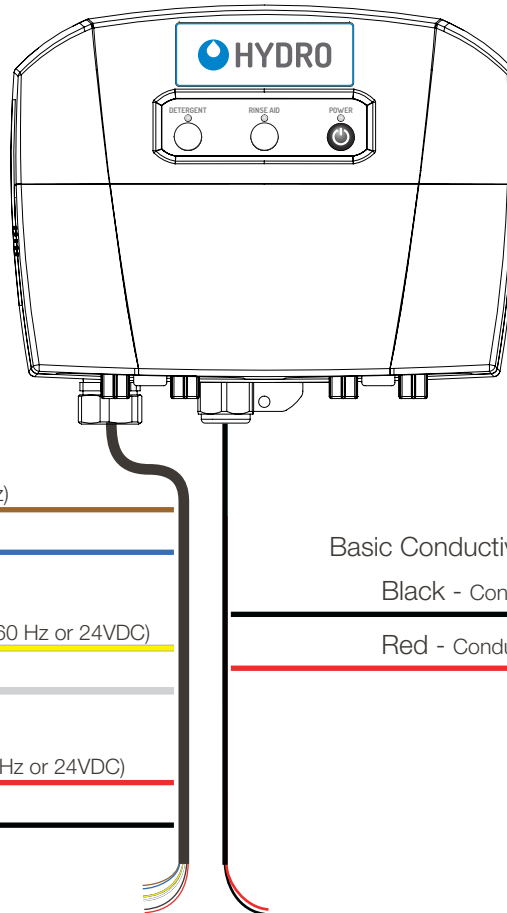

Main Power and Machine Signals

Main Power Input

Brown - Line / Hot (100-230V AC at 50/60 Hz)

Blue - Neutral

Detergent Signal

Yellow - Live or DC+ (24V to 250V AC at 50-60 Hz or 24VDC)

White - Neutral or DC -

Rinse Signal

Red - Live or DC + (24V to 250V AC at 50-60 Hz or 24VDC)

Black - Neutral or DC-

Sensor Probe Input

Basic Conductivity Probe

Black - Conductivity Circuit Wire 1

Red - Conductivity Circuit Wire 2

Basic Conductivity Probe Wiring

Although the basic conductivity probe wiring is pre-wired to the controller, you must make the connection to the probe installed on the washer.

- 1) Route the probe wires to the conductivity probe location and cut to fit if required.
- 2) Strip the wire ends and crimp on the ring terminals provided.
- 3) Connect the ring terminals to each of the probe connections, sandwiching each ring terminal onto the probe between the nuts and washers provided (see diagram at right). Ensure that connections are tight and secure.

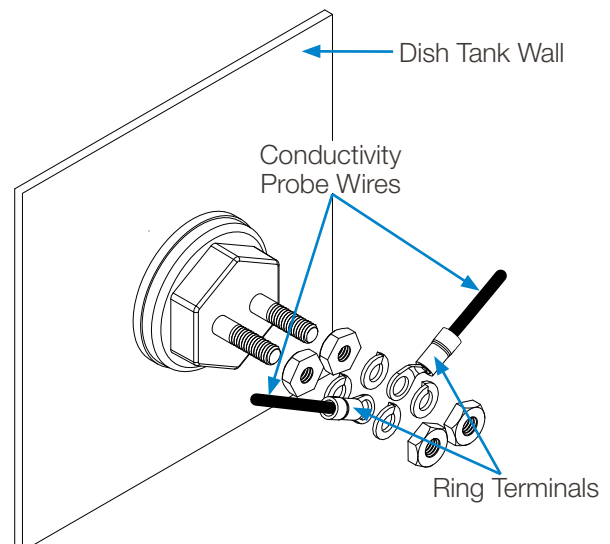

installation (continued)

Main Power Input Wiring

Power input to the DMx can be any voltage from 100-230 VAC at 50/60 Hz. For single phase systems, the brown wire of the seven-wire harness is connected to the Hot source and the blue wire is connected to the Neutral source, as shown to the right.

With a three phase supply, the DMx is a single-phase load. Line voltage is applied using just two wires (Brown and Blue). Avoid interconnection to power systems that are not ground-referenced. Choose a connection between a line (phase) and neutral, connecting the **brown wire to the line** and the **blue wire to the neutral**, following the illustrations below.

Main Power Input Wiring: **Single Phase AC Power**

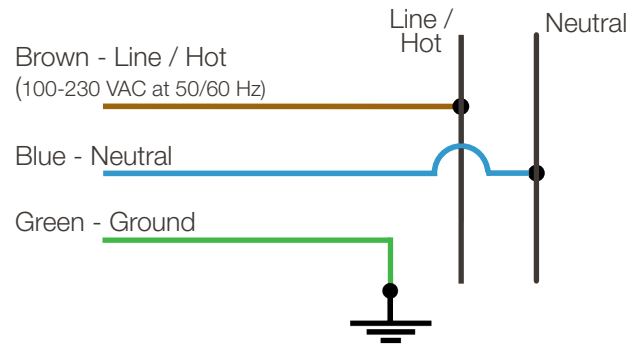

Main Power Input Wiring: **Three Phase AC Power**



NOTE: An accessible neutral is required. Connect between line and neutral **ONLY**.

1. 120/208 VAC WYE (includes Neutral)

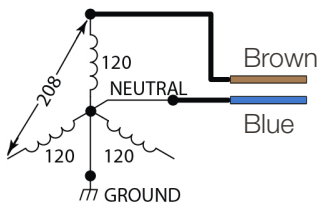

2. 120/240 VAC Delta with High Leg

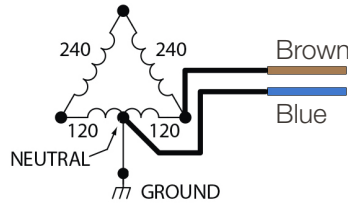

3. 220/380VAC or 240/415VAC WYE (includes Neutral)

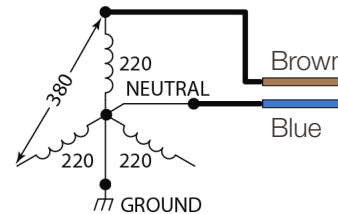

Detergent Signal Wiring

- Detergent signal input is optically isolated and draws no more than 20mA.
- It is a universal voltage input that accepts voltage between 24-250VAC nominal ($\pm 10\%$ fluctuation), or 24VDC nominal ($\pm 20\%$ fluctuation).
- Typical wiring locations are dispenser detergent power source or the wash motor contacts in the dish machine control panel. This power source is on when the dishwasher is running the wash pump.
- Connect **yellow (DC+)** and **white (DC-)** colored wires to detergent signal power source.

Detergent Signal Wiring

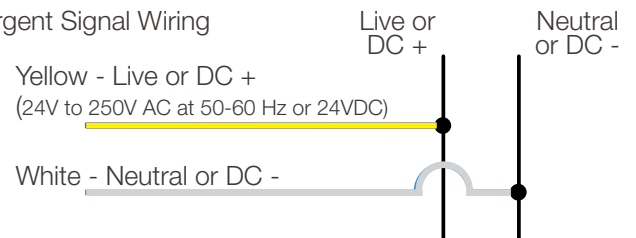

Rinse Signal Wiring

- Rinse signal input is optically isolated and draws no more than 20mA.
- It is a universal voltage input that accepts voltage between 24-250VAC nominal ($\pm 10\%$ fluctuation), or 24VDC nominal ($\pm 20\%$ fluctuation).
- Typical wiring locations are dispenser rinse power source or the rinse solenoid valve circuit in the dish machine control panel. This power source is live whenever the dishwasher is rinsing.
- Connect **red (DC+)** and **black (DC-)** colored wires to rinse signal power source.

Rinse Signal Wiring

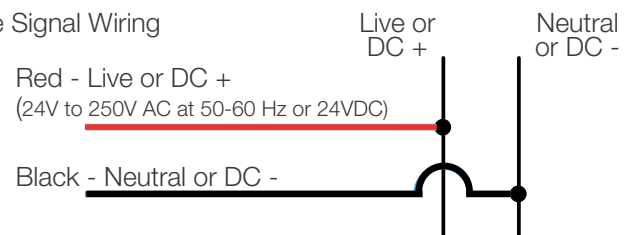

operation

Dispenser Control Pad

There are three or four buttons and corresponding LEDs on the DMx depending on whether a 2-product or 3-product system is in use. These buttons and LEDs allow for local interaction by the user.

Product Buttons

There is one button each for Detergent, Rinse, and Sanitizer. (Sanitizer used only on a 3-product system.) These buttons are intended to be used for the following purposes:

Priming

Only one pump can be primed at a time. To begin priming press any product button while the dispenser is idle. Attempts to prime while a detergent or rinse signal is active will be ignored. While the pump is priming, the green LED will flash once per second. Prime limits are configurable using the Hydro Connect Mobile Application within Bluetooth range, but the default prime limit is 30 seconds every hour. If the button is pushed a second time before the limit has expired, the priming operation will stop, and the LED will turn off. The priming operation can be repeated multiple times until the limit is reached. After the limit is reached, further attempts to prime will result in the product LED flashing orange once, indicating that the user must wait until the configurable lock-out period has elapsed.

Silencing the Buzzer







Critical alarms on the DMx will result in the sounding of an audible buzzer along with a solid or flashing red LED. Solid red indicates that the local kitchen staff can address the issue and flashing red indicates that a technician is needed. The buzzer can be muted for 10-minutes by pressing any button on the dispenser for a duration of one second. If the alarm is not cleared in 10-minutes, the buzzer will sound again.

Clearing Alarms

Most alarms can be cleared by pressing and holding the button on the affected product for a duration of 2 seconds. Alternatively, these alarms can be cleared with instruction from the "Manage Dispenser" screen in the Hydro Connect Mobile Application. The "Manage Dispenser" screens are described in more detail on page 11.

Product LEDs

There is one LED each for product button; Detergent, Rinse, and (if present) Sanitizer. As shown below these LEDs are used to convey pump status, maintenance alarms, or critical alarms.

LED Color	Fixed or Flashing	Buzzer	Indication
Green	Flashing		Off Pump is operating normally as part of a rack or is priming with no maintenance alarms or critical alarms.
	Fixed		Off There is an active detergent or rinse signal present and the pump is not dosing.
Red	Fixed		On This indicates that there is an out of product condition that the local staff can manage. This can be triggered for detergent if the dispenser is being run in probe mode and there are a configured number of racks run below the setpoint. Alternatively, this can be triggered on Detergent, Rinse or Sanitizer by using a depletion wand accessory
	Flashing		On This indicates that there is a critical alarm on one of the pumps that requires intervention by a technician. Depending on the product LED that is flashing, the following conditions are causes: <ul style="list-style-type: none"> • Detergent probe faulty (probe mode only) • Rinse temperature is low (requires optional rinse temperature sensor kit) • Detergent, Rinse, or Sanitizer pump jam
Orange	Fixed		Off This indicates that there is a non-critical maintenance alarm that the local staff can manage. The conditions that produce this type of alarm are: <ul style="list-style-type: none"> • If the detergent LED is illuminated, the Detergent tank temperature is low (requires optional temperature compensated probe) • All 3 LEDs are illuminated the Change Tank Water Alarm has been triggered based on the number of racks run since the last change.
	Flashing		Off This indicates that there is a non-critical maintenance alarm that requires intervention by a technician. The conditions that produce this type of alarm are: <ul style="list-style-type: none"> • If all product LEDs are flashing once per second, the dish machine needs to be delimed based on the number of days since the last delime. • If Detergent, Rinse, or Sanitizer are flashing twice per second, the corresponding pump is due to have a squeeze tube change according to the number of days of operation since the last change.



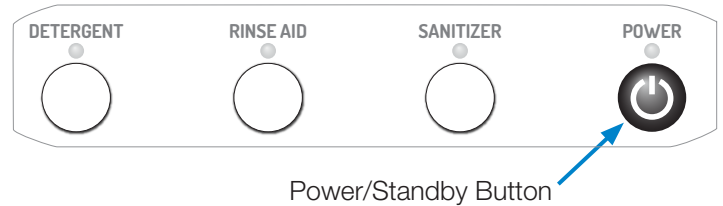

operation (continued)

Power/Standby Button

There is one button and LED labeled Power, on the DMx. This button can be pressed at any time to stop the DMx from priming, running, or receiving detergent or rinse signals from the dish machine. This button is especially useful when performing maintenance, such as changing squeeze tubes or delimiting the detergent tank.



Please note that pressing the Power button **does not isolate the dispenser from line voltage** and therefore, precautions still must be taken to avoid shock when working inside the cabinet.

LED Color	Fixed or Flashing	Buzzer	Indication
Green	Fixed		Off The dispenser is operating normally , meaning it is ready to receive detergent or rinse signals to begin dosing.
Red	Fixed		Off This indicates that the dispenser is currently in Standby mode and will not dose product when detergent or rinse signals are activated. Additionally, the prime feature will not operate.
	Flashing		Off The Power/Standby LED flashing red once per second indicates that the dispenser's hardware (e.g. real-time clock, flash memory, or pump configuration) is malfunctioning .
Orange	Flashing		Off 1) Maintenance Alarm - Dispenser has switched from Probe to Probeless Mode due to a faulty probe. (Probeless Autoswitch) 2) After clearing a critical alarm.
Blue	Fixed		Off This indicates that the dispenser is connected to a mobile device via Bluetooth and the Hydro Connect Mobile Application.

programming

Programming Overview

The DMx dispenser is programmed and controlled using the Hydro Connect Mobile application that is available through app stores for either iOS or Android.

The mobile application is compatible with iPhones (6S and beyond), iPads, and Android Devices (API 23 - Android 6.0 and beyond).

Please note that portions of the Hydro Connect Mobile application may not be available to all user types. For example, a Kitchen Manager may not have the ability to access the SETUP DISPENSER menu because that responsibility is reserved for Chemical Company technicians.

Logging into the Hydro Connect Mobile App

To access your dispenser via the Hydro Connect Mobile App, you must be set up as a user within your company hierarchy.

If you are not yet set up, you may:

- 1) Contact your Company Admin who manages all the Hydro Connect users.
- 2) Contact Hydro via 800-543-7184 or contact-hydro@hydrosystemsco.com
- 3) Fill out and submit a new user request form.

Once you are set up with an account, you can open the Hydro Connect Mobile app and fill in your username and password.

If you choose, you may check the box stating "Remember my login information" to simplify and speed-up future access.

programming (continued)

Home Screen Overview

After logging in, you will land on the HOME screen. From this screen you will be able to connect to any device that is within your user responsibilities that is within Bluetooth range.

You also will be able to use the Toolbar Ribbon at the bottom of the mobile application to do common tasks like:

- **Log-out:** Logs out the user and returns to the Log-In screen
- **Settings:** Allows the user to set up common App settings like language, units of measurement, connectivity/data transmission preferences, and date format.
- **Home:** Returns to the Home screen
- **Guides:** Provides quick access to Hydro's product literature and instruction manuals
- **Hydro:** Provides quick access to Hydro's contact information and website

Connecting to a Dispenser from the HOME Screen

From the HOME screen, you will automatically be able to view information on all the dispensers that are within Bluetooth range (typically around 30 feet/ 9 meters).

When multiple dispensers are present, one can select the Filter icon to simplify selection of the desired dispenser. One filter allows the user to limit the dispensers that are visible on the Home screen to those that are Close (within 5 feet/1.5 meters) and/or those that are Mid-Range (further than 5 feet/1.5 meters away).

Additionally, the user can view the dispenser name, Power LED status, and the presence of any alarms prior to connecting.

Selecting one of the available dispensers will automatically initiate the connection process. While this occurs, the dispenser will transfer some of its records to the mobile application. This may take a few seconds.

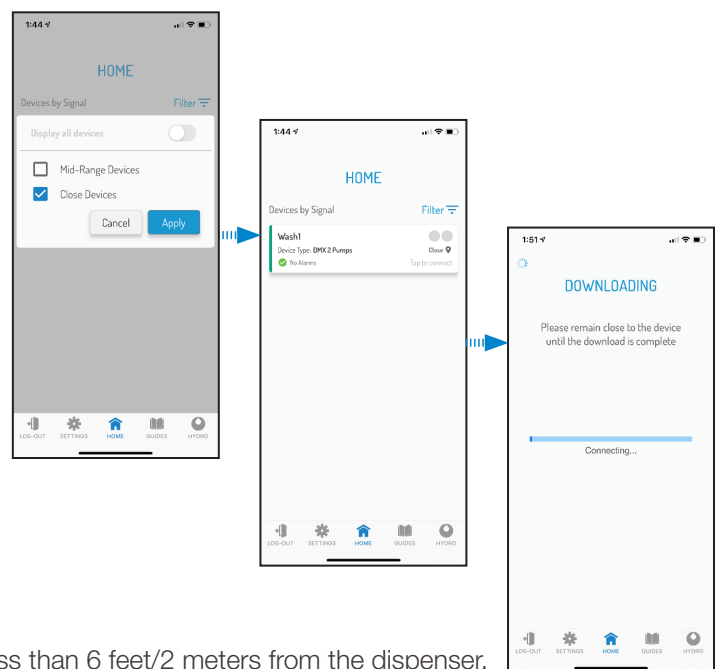

NOTE: For best results, it is recommended to connect when less than 6 feet/2 meters from the dispenser.

REPORT Screen Overview

The REPORT menu allows a Kitchen Manager or Technician to view summary information locally. More detailed historical reports and professional graphical reports are available through the Hydro Connect web portal.

The types of reporting included in the Hydro Connect Mobile app are:

- **Chemical Usage:** presents a tabular display of the fluid volume (oz or ml) or solid weight (lb or kg) of detergent, rinse aid, or sanitizer used in the current week or month. Note that this functionality requires each product to have been calibrated by a Technician.
- **Productivity/Racks:** presents a tabular display of the number of racks that have been run by the dispenser in the current week or month.
- **Alarms:** presents a tabular display of the number of racks that were completed with each type of alarm in the current week or month.

The screenshot shows the 'REPORT' screen for 'Hydro Kitchen'. It has a 'Report Type' section with 'Chemical Use' checked, and 'Racks' and 'Alarms' unchecked. The 'Report Range' section has '7 Days' checked and '1 Month' unchecked. Below is a table for 'Pump 1: Detergent' with columns for 'Days' and 'Usage'. The data is as follows:

Days	Usage
Mar 18, 2021	141 g
Mar 17, 2021	18 g
Mar 16, 2021	0 g
Mar 15, 2021	0 g
Mar 14, 2021	0 g
Mar 13, 2021	0 g

Reports Screen

programming (continued)

MANAGE DISPENSER Screen Overview

The MANAGE DISPENSER screen is a dashboard that allows users to quickly see all the pertinent information about the dispenser the Hydro Connect Mobile app is connected to.

The various sections of this screen are described in detail below:

- Dispenser Information:** This section contains information about the Dispenser Name (e.g. Hydro Kitchen), the dispenser model#, and dispenser serial#, plus the basic configuration in terms of Probe vs Probeless and Machine Type (Door, Conveyor, or Alt. Door)
- Report Button:** Pressing this button will lead the user to a menu where summary/local reporting on productivity (racks), chemical usage, and alarms can be generated for various time horizons.
- Dispenser Status:** This section contains real-time information regarding the status of each chemical and its associated pump/solenoid. At a glance, the user can see if there are any maintenance alarms or critical alarms, whether the pump is running, or if it is idle.
- Maintenance:** This section assists the user in knowing when and how to complete common maintenance items when there is an associated alarm. Completing maintenance items using this section will automatically clear the alarm and reset the timer for the next alarm.

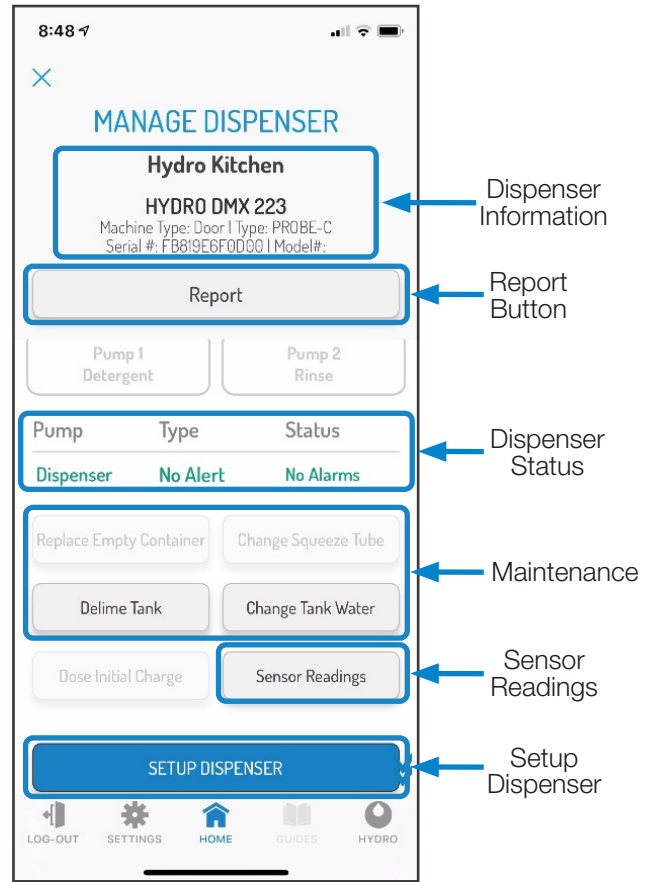

Maintenance Step:	Most Often Completed By:
Replace Empty Container	Kitchen Manager
Change Dirty Tank Water	Kitchen Manager
Dose Initial Charge Manually	Kitchen Manager
Change a Worn Squeeze Tube	Technician
Delime Tank	Technician

- Sensor Readings:** This maintenance selection allows the user to see the live readings of any connected sensors, such as conductivity, tank temperature, or rinse temperature. It also displays the corresponding setpoint or alarm settings for each sensor.
- Setup Dispenser:** Pressing this button will advance to the next menu that allows a Technician to program the device's dosing parameters

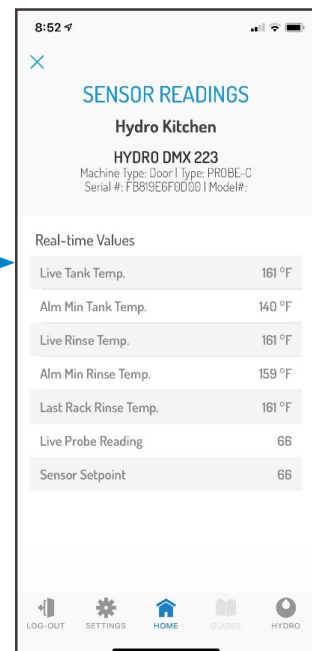

Sensor Readings

SETUP Screen Overview

From the SETUP DISPENSER menu, there are multiple ways for a Technician to program all the dosing parameters. These include:

- **Guided Setup:** This section will walk the user through all the required settings to operate the DMx at a basic level. It will not cover non-essential settings, like costs, alarms, or Asset Management, which are covered in the Configure Alarms or Advanced Setup menus.
- **Setup from File:** Intended to save the user valuable installation time, this allows for a pre-configured setup file to be applied to the DMx vs. configuring it directly.
NOTE: Calibration values for each product and the dispenser names will **not** be transferred as part of the Setup File.
- **Configure Alarms:** This section allows each alarm to be enabled/disabled and for key settings for each alarm, such as the “Remind After” periods, to be customized.
- **Advanced Setup:** This section allows the user to configure several non-essential, value added features, such as:
 - **User prime limits:** Limits the number of seconds that prime can be operated over a set duration in hours (e.g. 60 seconds every 8-hour shift)
 - **Costs:** Allows costs for each product to be entered in currency per unit volume. This is useful for creating cost per rack reports in Hydro Connect.
 - **24V Output:** The DMx can power external devices with a 24 VDC output that can be made operational through the mobile application.
 - **Download data:** The mobile application can extract the records stored in the dispenser’s memory onto the mobile device to be uploaded later into the Hydro Connect Cloud.
 - **Asset Management:** Allows the device installation date and location to be tracked by serial number through Hydro Connect.
- **Quick Reference:** This section allows for a quick check to key parameters on each product pump and for some values like dispensing speed to be adjusted quickly.

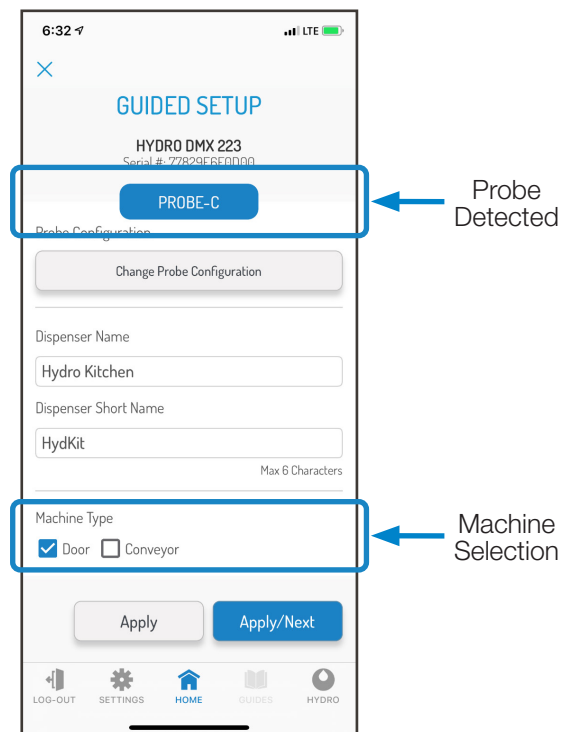
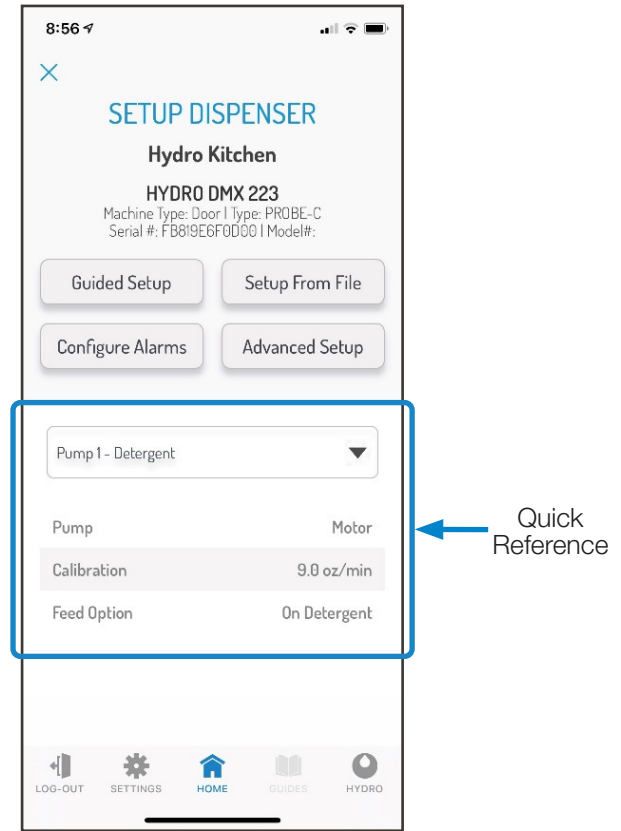

GUIDED SETUP - Probe Mode

GUIDED SETUP will walk the user through all the required settings to operate the DMx at a basic level. The fields required for this process depend on whether the dispenser is using a probe for dispensing detergent and the type of dish machine that it is connected to. In general, there are 5 possibilities including:

- Probe Mode, Door Machine
- Probe Mode, Conveyor Machine
- Probeless Mode, Door Machine
- Probeless Mode, Conveyor Machine
- Probeless Mode, Alternate Door Machine

GUIDED SETUP (continued)

From the first screen, the user can change the Name of the dispenser and the Short Name which is broadcast via Bluetooth from the HOME screen.

To ensure that the right settings are configured, the user must then indicate whether a probe is being used or not and then select the Machine Type.

NOTE: Once Probe mode is selected, the DMx will automatically determine the type of probe in use.

The options are:

- Basic Conductivity: **“PROBE-C”**
- Conductivity/Temp Compensated: **“PROBE-CT”**
- Inductive Probe: **“PROBE-I”**

Probe Mode on a Door Machine

To configure a DMx unit that utilizes a conductivity probe on a Door Machine, start with the detergent pump first.

Detergent

Since the detergent is controlled by the reading of the probe, there are several settings that must be configured to help the dispenser operate accurately.

NOTE: The pump style (Motor or Solenoid) will automatically be determined by the DMx controller.

Probeless Autoswitch (Door)

Probeless Autoswitch is a feature that, when enabled, automatically switches the unit into Probeless mode if problems are detected with the probe readings. More specifically, if the probe reading is zero (0) or greater than ninety (90) for a configured number of racks; it will trigger the unit to switch to Probeless mode without interrupting the operation. (When this occurs the Power and Detergent LEDs will flash Yellow indicating the probe requires maintenance.)

If enabled in the Guided Setup, the user will be prompted to establish the Probeless Dosing parameters for detergent, in case a switch takes place.

For a door machine, this includes the initial charge time (0-200 sec) and the incremental dose time (1-20 sec).

Pulse Feeding

Pulse feeding is a feature for dosing in Probe Mode whereby the detergent motor stops running continuously and begins pulsing at a configured % of the setpoint. This allows the dosing to be more precise and avoid overshooting the setpoint if there is a time delay in between the detergent entering the tank and its detection via the probe.

If enabled, there are multiple ways to configure when pulse feeding will begin and the frequency of the pulses, as shown on the next page.

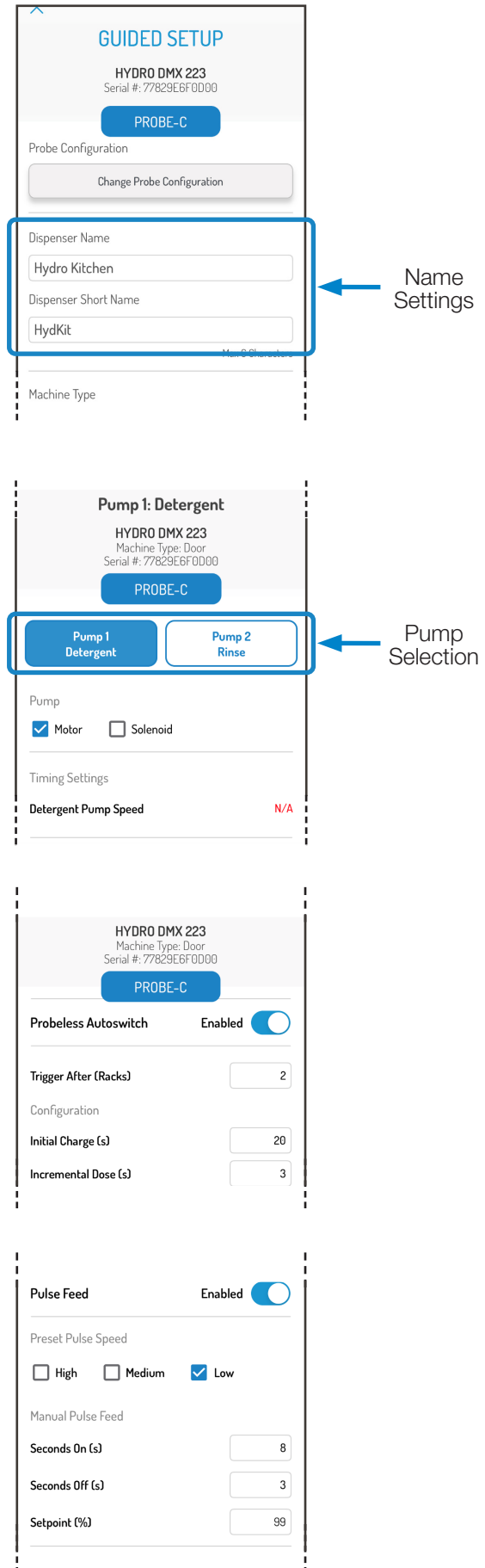

GUIDED SETUP (continued)

Pulse Feeding (continued)

Preset High / Medium / Low Pulsing

If the user is uncertain about how to set up their pulse feeding, Hydro has provided some preset common pulse feeding settings. They are defined as:

- **High:** The pump will begin pulsing at 90% of the setpoint value. It will run for 6 seconds and then will be off for 1 second and repeat until a value at or above the setpoint is reached.
- **Medium:** The pump will begin pulsing at 80% of the setpoint value. It will run for 2 seconds and then will be off for 6 second and repeat until a value at or above the setpoint is reached.
- **Low:** The pump will begin pulsing at 70% of the setpoint value. It will run for 1 second and then will be off for 6 seconds and repeat until a value at or above the setpoint is reached.

Customizable Values: If the user does not prefer the presets, they can manually define specific values for Seconds On (1-10 sec), Seconds Off (1-10 sec) and Setpoint % (10-95%).

Establishing Probe Setpoint

To dose detergent in probe mode, the user must properly titrate the wash tank and establish this as the setpoint for the conductivity probe. When the conductivity probe reads a value below the setpoint and the detergent signal is on, the dispenser will dose detergent until the probe reaches the setpoint.

The process to do this is:

- 1) If you already know the appropriate setpoint, you can enter it manually at any time.
- 2) Otherwise, fill the wash tank with fresh water and properly titrate the tank with detergent.
- 3) When the tank is properly titrated, press the Get Reading button to read the live conductivity reading in the tank.
- 4) Once the live reading is satisfactory, press Set Setpoint to establish the probe setpoint.

Liquid Pump Calibration

In order to properly track chemical usage, each liquid pump must be calibrated to establish a relationship between product volume (ounces or milliliters) and time.

Pressing the Calibrate Pump button will begin the process of calibration by prompting the user to prepare to safely dispense product. Please wear appropriate PPE, follow your company guidelines, and prepare a container with at least 12 oz (355 ml) of volume to catch any dispensed product.

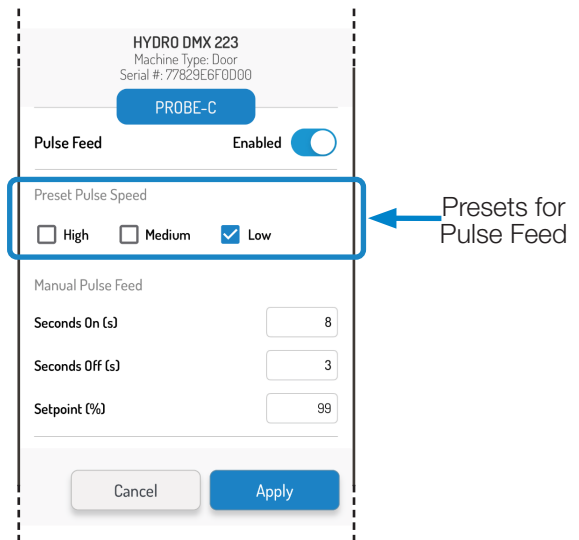

Presets for Pulse Feed

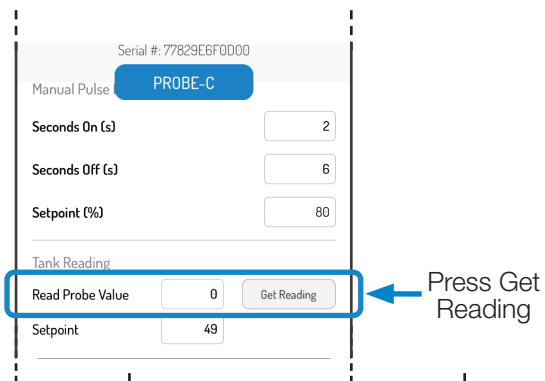

Press Get Reading

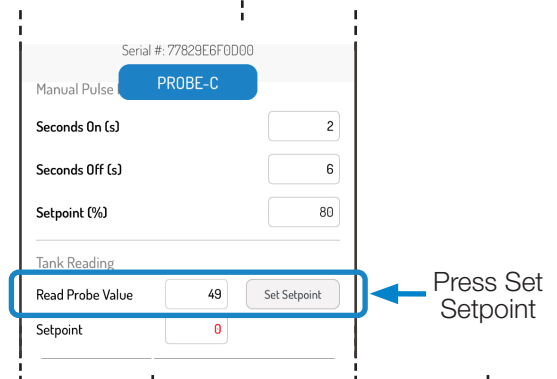

Press Set Setpoint

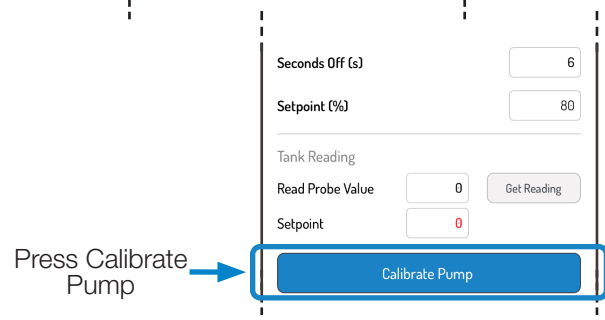

Press Calibrate Pump

GUIDED SETUP (continued)

Liquid Pump Calibration (continued)

Liquid pumps can be calibrated using a fixed Time or fixed Volume. Regardless of the method chosen, before beginning, ensure that the pump is completely primed with the inlet and outlet tubing filled with product.

NOTE: Liquid pumps are always calibrated at full speed. If the speed for the rinse pump is then adjusted below the maximum speed, the usage information will be scaled proportionally.

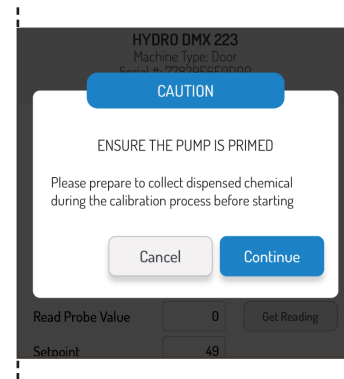

Calibration by Time

When calibrating by time, the pump will run for a fixed time of 20 seconds. To begin the process:

- 1) With your container in position, press Start. The pump will begin running and a countdown from 20 will begin. You can cancel the process at any time by pressing Cancel.
- 2) Once the pump stops, enter the volume that was dispensed in 20 seconds.
- 3) Check that the values are correct, and press Apply.

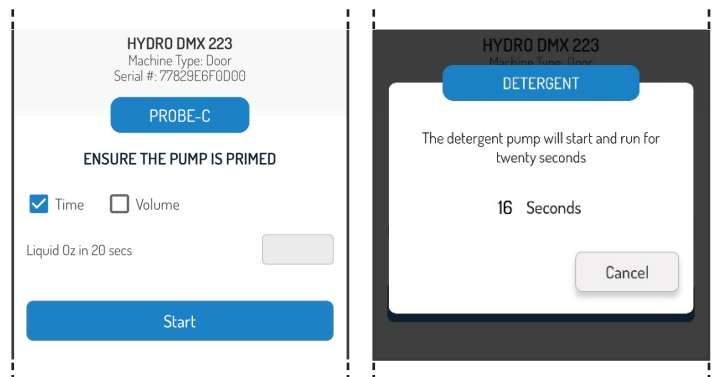

Calibration by Volume

Alternatively, users may opt to perform a calibration by volume.

Using this method, the pump must be started/stopped by the user when it has dosed a set volume of product. To begin the process:

- 1) The user must enter the volume they wish to dispense. Hydro recommends that at least 4 oz (120 ml) be used for volumetric calibrations.
- 2) With your container in position, press Start to begin the process. The pump will begin running and counting from zero. When the desired volume is dispensed press Stop.
- 3) Check that the values are correct, and press Apply.

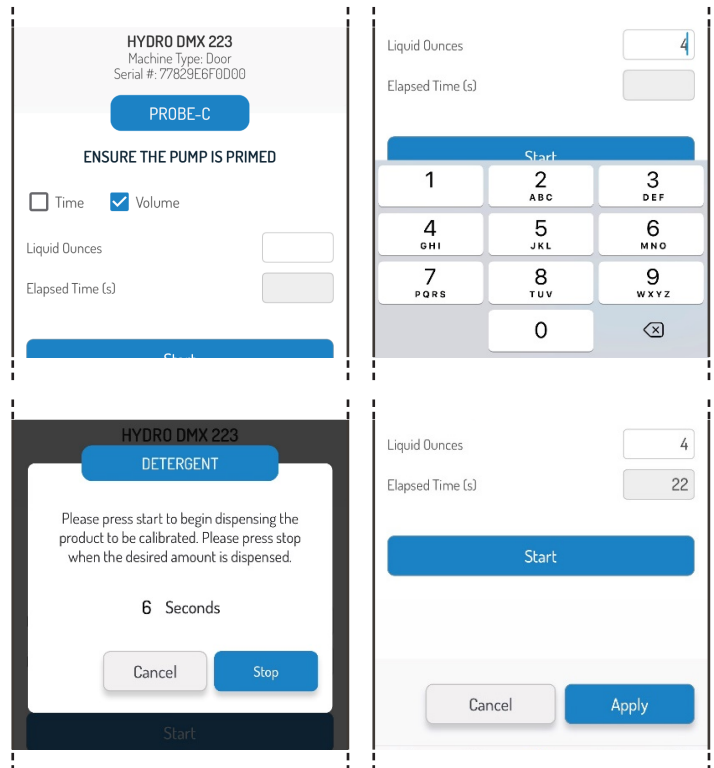

Solenoid (Solids) Calibration

Calibrating a solenoid for solid chemical dispensing can only be done using a fixed Time and measuring the grams of product dispensed.

It is important to measure the mass (**always in grams**) of the solid chemical container using a scale prior to beginning the calibration process.

GUIDED SETUP (continued)

Solenoid (Solids) Calibration (continued)

Calibration by Time

When calibrating by time, the solenoid will open for a fixed time of 20 seconds, allowing water to spray and dissolve the solid product. To begin the process:

- 1) With outlet of the dissolver bowl routed to a drain or the dish machine, press Start. The solenoid will open and a countdown from 20 will begin. You can cancel the process at any time by pressing Cancel.
- 2) Once the solenoid stops, weigh the solid chemical container a second time and enter the mass (grams) dispensed over the 20 seconds by taking the difference between the two mass measurements.
- 3) Check that the value for the weight of solid product consumed (**in grams**) is correct (see example at right), and press Apply (not shown).

Rinse

- 1) To set up the rinse dispensing parameters for a unit operating in **Probe Mode** on a **Door Machine**, scroll to the top and select the **Rinse Pump**.
- 2) Next, enter the following:
 - **Rinse Aid Pump Speed (5-55 RPM):** This is the speed that the pump will run at whenever the rinse signal is active.
 - **Rinse Aid Time Delay (0-30s):** This is the amount of time that the rinse signal needs to be active before the rinse pump will begin dispensing.

NOTE: Door machine setups utilize the Rinse Saver feature that prevents the rinse pump from running more than 20 seconds per rack.

- 3) Set Rinse Aid Feed Option:

- **Rinse on Rinse:** The rinse pump will run whenever the rinse signal is active as per the above configuration parameters.
- **Rinse on Detergent:** The rinse pump will run whenever the detergent signal is received active as per the above configuration parameters for a set duration that is entered by the user (seconds). This option is not commonly used but may be appropriate on machines without a separate rinse signal.

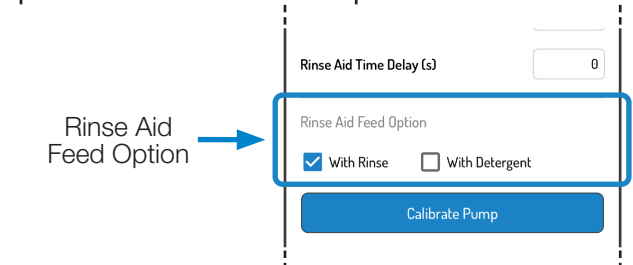
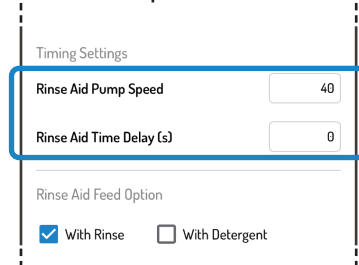
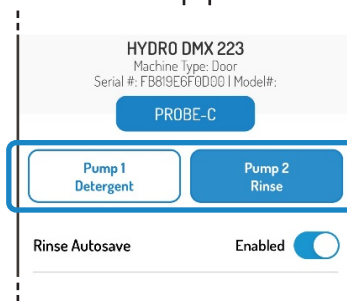
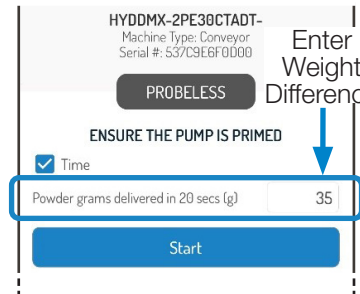
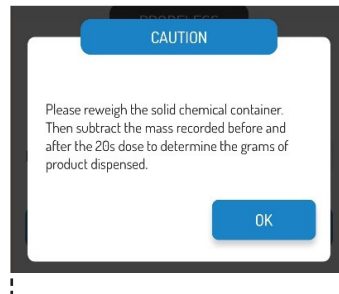
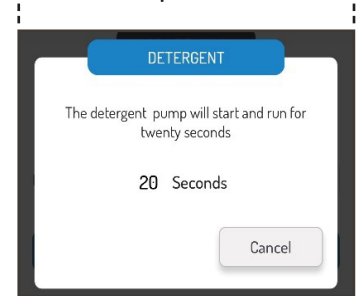
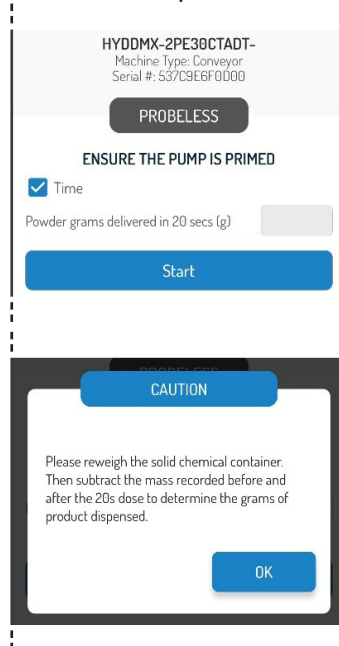
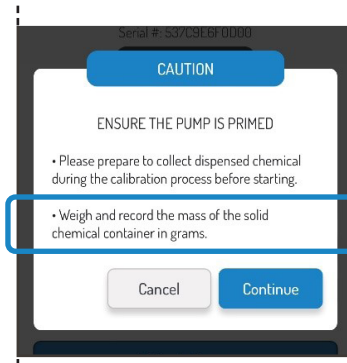

GUIDED SETUP (continued)

Sanitizer (3-Product Models Only)

- 1) To set up the sanitizer dispensing parameters for a unit operating in **Probe Mode** on a **Door Machine**, scroll to the top and select the **Sanitizer Pump**.
- 2) Next, enter the following:
Sanitizer Pump Speed (5-55 RPM): This is the speed that the pump will run at whenever the rinse signal is active.

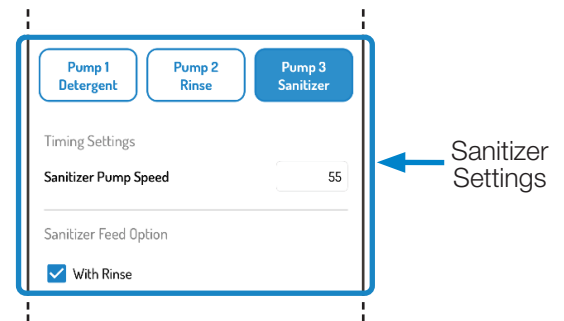

Accepting the Guided Setup

To complete the Guided Setup or complete changes made to a prior setup, scroll to the bottom and press Apply.

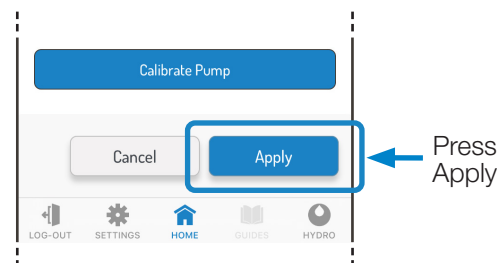

Probe Mode on a Conveyor Machine

To configure a DMx unit that utilizes a conductivity probe on a Conveyor Machine, start on the Guided Setup Screen.

- 1) Confirm that the blue button is set to Probe and select Conveyor as the Machine Type.
- 2) When this is done, the user will be prompted to enter the Conveyor Rack Time (in seconds). This setting helps the dispenser count racks in Conveyor Mode.
 - The field can be set from 0-90 seconds.
 - Whereas Door Mode counts a rack every time the detergent and rinse signals are cycled, in Conveyor Mode, a rack is counted when the rinse signal is on continuously for the configured Conveyor Rack Time.
 - If you are unsure about what to enter as the Conveyor Rack Time, you can measure the amount of time it takes for a rack of dishes to pass through the rinse portion of the conveyor.

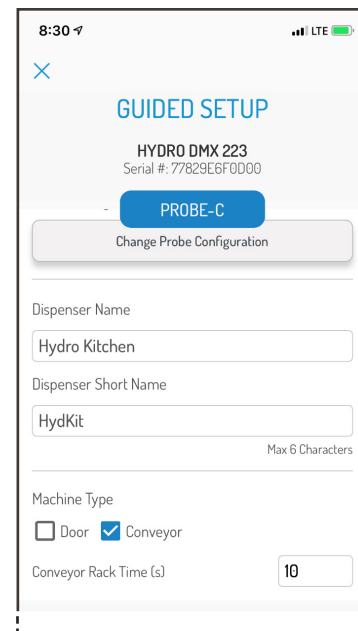

Detergent

Probeless Autoswitch (Conveyor)

Probeless Autoswitch is a feature that, when enabled, automatically switches the unit into Probeless mode if problems are detected with the probe readings.

More specifically, if the probe reading is zero (0) or greater than ninety (90) for a configured number of racks (enter in the field titled "Trigger After") it will trigger the unit to switch to Probeless mode without interrupting the operation.

GUIDED SETUP (continued)

Probeless Autoswitch (Conveyor) (continued)

When this occurs the Power and Detergent LEDs will flash Yellow indicating the probe requires maintenance.

If enabled in the Guided Setup, the user will be prompted to establish the Probeless Dosing parameters for detergent, in case a switch to Probeless Mode does take place.

For a Conveyor machine, this includes:

- Initial charge time (0-200 sec)
- Incremental dose time (1-20 sec)
- Dose Interval (1-3 Racks).

These fields are described in greater detail on page 19 on Probeless Mode.

NOTE: All other detergent settings for Probe Mode on a Conveyor Machine are programmed identically to those on a Door Machine (see page 13).

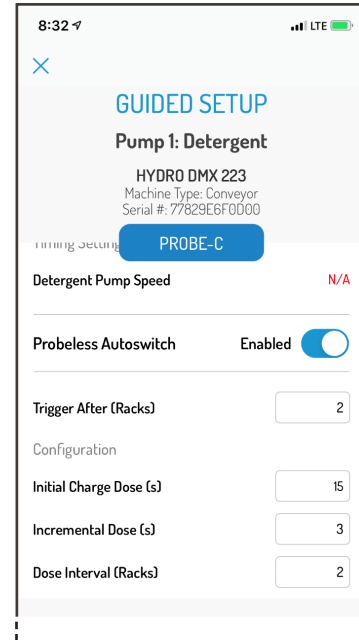

Rinse

1) To set up the rinse dispensing parameters for a unit operating in **Probe Mode** on a **Conveyor Machine**, scroll to the top and select the **Rinse Pump**.

2) Next, enter the following:

- **Rinse Aid Pump Speed (5-55 RPM):** This is the speed that the pump will run at whenever the rinse signal is active.
- **Rinse Aid Feed Option:**
 - Rinse on Rinse- The rinse pump will run whenever the rinse signal is active as per the above configuration parameters.

NOTE: There is no Rinse Pump Delay in Conveyor Mode.

NOTE: There is no Rinse on Detergent setting in Conveyor Mode.

Sanitizer (3-Product Models Only)

1) To set up the sanitizer dispensing parameters for a unit operating in **Probe Mode** on a **Conveyor Machine**, scroll to the top and select the **Sanitizer Pump**.

2) Next, enter the following:

Sanitizer Pump Speed (5-55 RPM): This is the speed that the pump will run at whenever the rinse signal is active.

Calibrate Pump / Solenoid

Pump or solenoid calibration for Probe, Conveyor Mode is done identically to the process described starting on page 14.

When all settings for Detergent and Rinse have been set, press Apply to complete the Guided Setup.

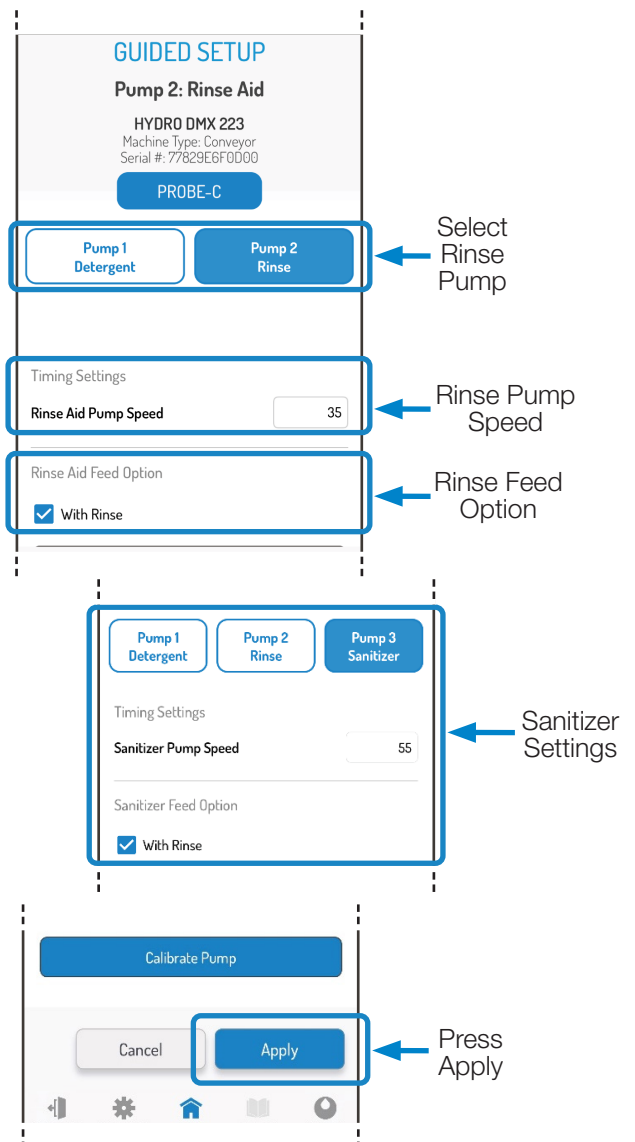

GUIDED SETUP - Probeless Mode

From the first Guided Setup screen, the user can change the dispenser into Probeless Mode by pressing the gray button labeled “Change Probe Configuration” and selecting “No”. The user can also select whether a temperature sensor is being used in the wash tank and the machine type at this time.

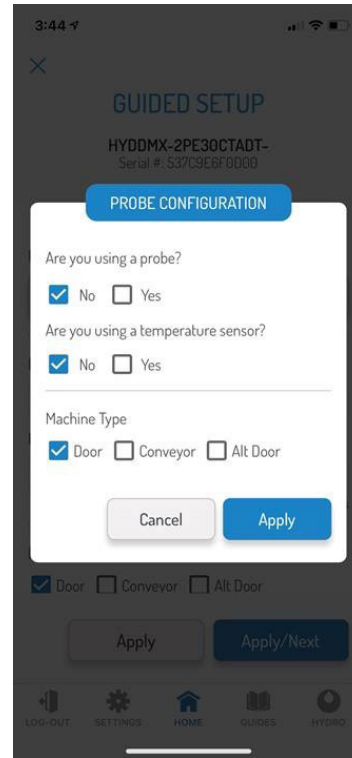
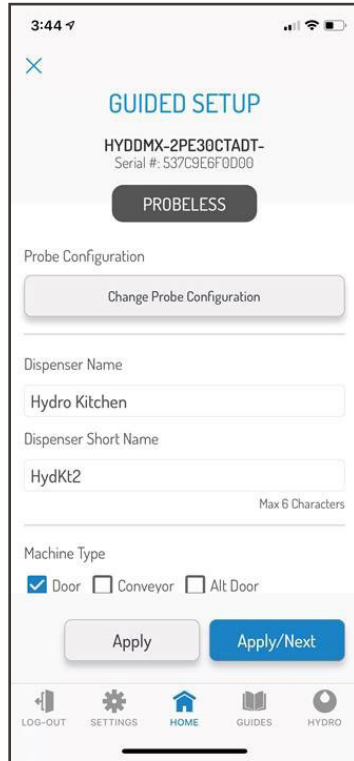

If a user is operating in Probeless or Time Mode to dispense detergent, there are three possibilities for machine type that will be explained in greater detail:

- Probeless Mode, Door Machine
- Probeless Mode, Conveyor Machine
- Probeless Mode, Alternate (Alt) Door Machine

Probeless Mode on a Door Machine

Detergent

In Probeless mode for a door machine, the dispensing of detergent is configured for set amounts of time depending on whether an initial charge or incremental dose is triggered.

Initial Charge (0-200s): An initial charge is meant to be dispensed every time the tank is drained and refilled with fresh water. In Probeless, Door Mode, it is triggered when a Rinse signal is received that is not preceded by a Detergent signal within 90 seconds.

Incremental Dose (0-20s): An incremental dose in Probeless, Door Mode is dispensed each rack when the detergent signal is triggered on for the 3 second signal acceptance time. When this occurs, the incremental dose will dispense and the pump will stop. To trigger another incremental dose, the rinse signal needs to cycle on/off to count the current rack and then a new detergent signal would need to be received.

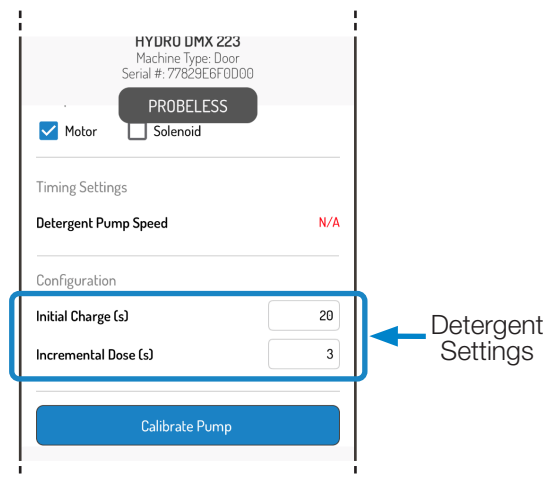

GUIDED SETUP - Probeless Mode (continued)

Detergent (continued)

Calibrate Pump / Solenoid

Pump or solenoid calibration for Probeless, Door Mode is done identically to the process described starting on page 14.

Rinse

- 1) To set up the rinse dispensing parameters for a unit operating in **Probeless Mode** on a **Door Machine**, scroll to the top and select the **Rinse Pump**.
- 2) Next, enter the following:
 - **Rinse Aid Pump Speed (5-55 RPM):** This is the speed that the pump will run at whenever the rinse signal is active.
 - **Rinse Aid Time Delay (0-30s):** This is the amount of time that the rinse signal needs to be active before the rinse pump will begin dispensing.

NOTE: Door machine setups utilize the Rinse Saver feature that prevents the rinse pump from running more than 20 seconds per rack.

- 3) Set Rinse Aid Feed Option:

- **Rinse on Rinse:** The rinse pump will run whenever the rinse signal is active as per the above configuration parameters.
- **Rinse on Detergent:** The rinse pump will run whenever the detergent signal is active as per the above configuration parameters for a set duration that is entered by the user (seconds). This option is commonly used on the Door machines seen in Europe.

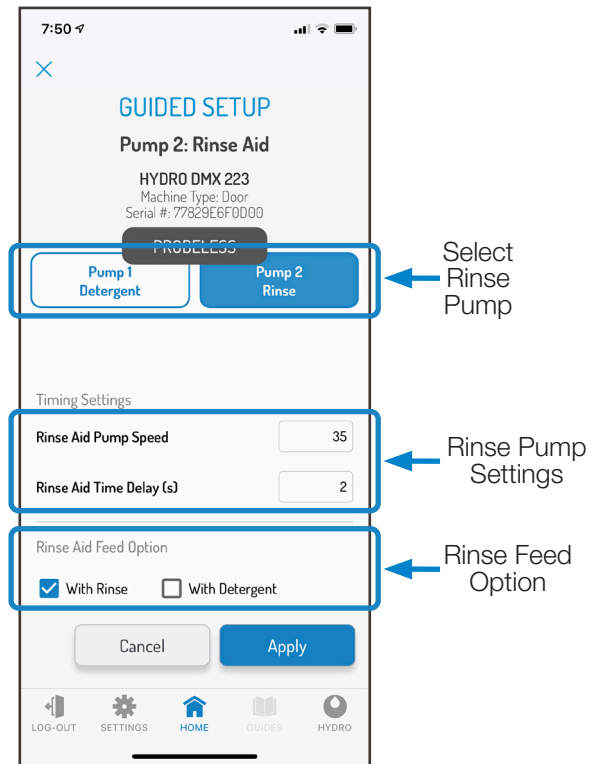

Sanitizer (3-Product Models Only)

- 1) To set up the sanitizer dispensing parameters for a unit operating in **Probeless Mode** on a **Door Machine**, scroll to the top and select the **Sanitizer Pump**.
- 2) Next, enter the following:
 - **Sanitizer Pump Speed (5-55 RPM):** This is the speed that the pump will run at whenever the rinse signal is active.

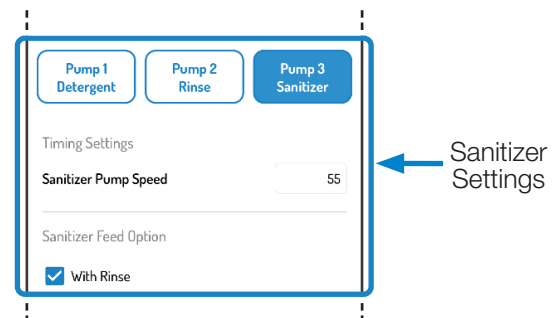

Calibrate Pump / Solenoid

Pump or solenoid calibration for Probeless, Door Mode is done identically to the process described starting on page 14.

When all settings for Detergent and Rinse have been set, press Apply to complete the Guided Setup.

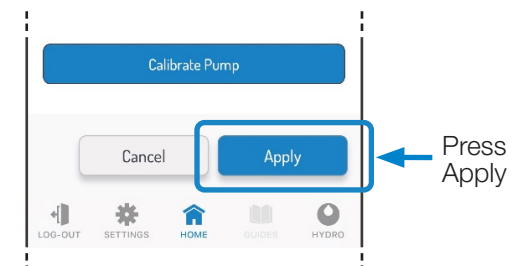

GUIDED SETUP - Probeless Mode (continued)

Probeless Mode on a Conveyor Machine

To configure a DMx unit that utilizes Probeless/Time mode on a Conveyor Machine, start on the Guided Setup Screen.

1) Confirm that the gray button is set to Probeless and select Conveyor as the Machine Type.

2) When this is done, enter the Conveyor Rack Time (in seconds). This setting helps the dispenser count racks in Conveyor mode.

- Whereas Door Mode counts a rack every time the detergent and rinse signals are cycled, in Conveyor mode, a rack is counted when the rinse signal is on continuously for a set amount of time.
- The field can be set from 0-90 seconds.
- If you are unsure about what to enter as the Conveyor Rack Time, you can measure the amount of time it takes for a rack of dishes to pass through the rinse portion of the conveyor.

When complete, press Apply/Next to continue setting up the dosing parameters for Detergent and Rinse.

Detergent

Detergent settings for Probeless Mode on a Conveyor Machine require the following fields to be set:

Initial Charge (0-200s): An initial charge is meant to be dispensed every time the tank is drained and refilled with fresh water. In Probeless, Conveyor Mode, it is triggered when the detergent signal is received and stays on for 10 seconds. The detergent signal in this case should be wired to a signal that is on once per drain/fill cycle such as an “on light,” the on/off switch on the dish machine, or if present, or an electrical tank heat circuit between the tank heater switch and the thermostat. If the dish machine does not have the appropriate signals, please contact Hydro Technical Support.

Incremental Dose (0-20s): An incremental dose is dispensed in Probeless, Conveyor Mode after racks complete and are counted (per the Conveyor Rack Time). The incremental dose will dispense for the time setting, and the pump will stop. To trigger another incremental dose, the proper number of racks must be completed.

Dose Interval (Every 1-3 Racks): In some cases on conveyor machines, the user may not want to inject detergent on every rack. If that is the case, the Dose Interval can be increased to dispense every 2 or 3 racks instead.

Calibrate Pump / Solenoid

Pump or solenoid calibration for Probeless Conveyor Mode is done identically to the process described starting on page 14.

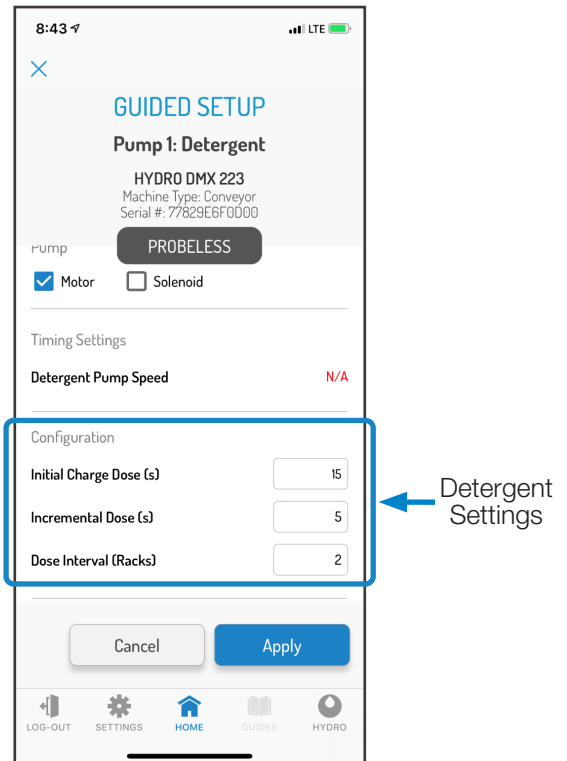

GUIDED SETUP - Probeless Mode (continued)

Probeless Mode on a Conveyor Machine (continued)

Rinse

- 1) To set up the rinse dispensing parameters for a unit operating in **Probeless Mode** on a **Conveyor Machine**, scroll to the top and select the **Rinse Pump**.
- 2) Next, enter the following:
 - **Rinse Aid Pump Speed (5-55 RPM):** This is the speed that the pump will run at whenever the rinse signal is active.
 - **Rinse Aid Feed Option:**
 - Rinse on Rinse- The rinse pump will run whenever the rinse signal is active as per the above configuration parameters.

NOTE: There is no Rinse Pump Delay in Conveyor Mode.

NOTE: There is no Rinse on Detergent setting in Conveyor Mode.

Sanitizer (3-Product Models Only)

- 1) To set up the sanitizer dispensing parameters for a unit operating in **Probeless Mode** on a **Conveyor Machine**, scroll to the top and select the **Sanitizer Pump**.
- 2) Next, enter the following:
 - **Sanitizer Pump Speed (5-55 RPM):** This is the speed that the pump will run at whenever the rinse signal is active.

Calibrate Pump / Solenoid

Pump or solenoid calibration for Probeless Conveyor Mode is done identically to the process described starting on page 14.

When all settings for Detergent and Rinse have been set, press Apply to complete the Guided Setup.

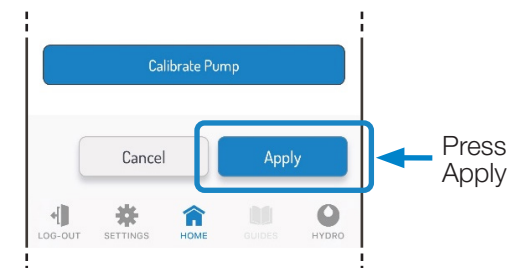
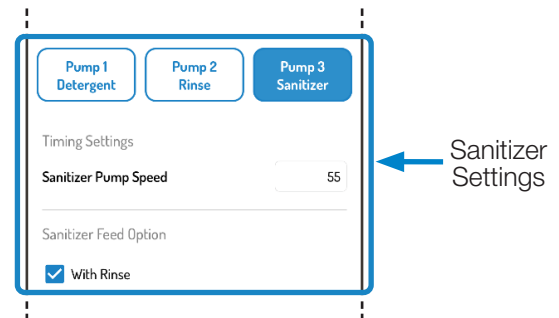
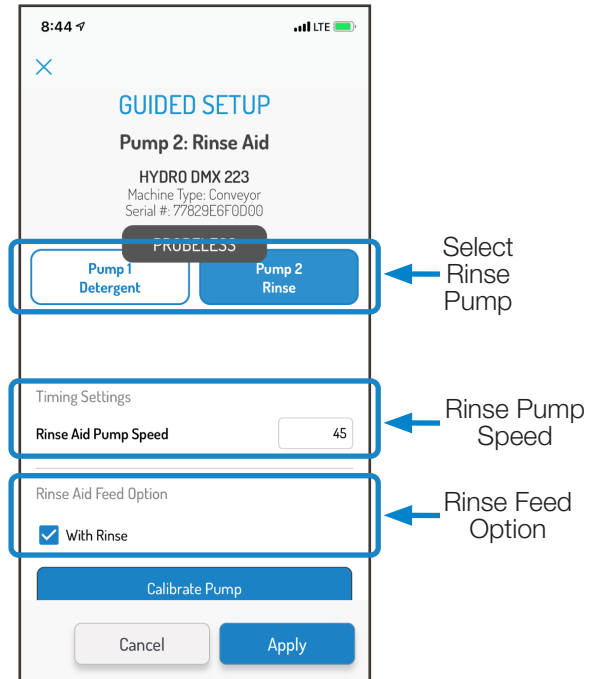

GUIDED SETUP - Probeless Mode (continued)

Probeless Mode on an Alternate (Alt) Door Machine

An Alternate Door Machine is a Door Machine that has two independent solenoids for the fill and for the rinse process.

This means that there is no rinse signal active when the system is filling, therefore the logic for dosing detergent initial charges is different for an Alternate Door.

To configure a DMx unit that utilizes Probeless/Time mode on an Alternate (Alt) Door Machine, start on the Guided Setup Screen.

Confirm that the gray button is set to Probeless, then select **Alt Door** as the Machine Type.

When complete, press Next to continue setting up the dosing parameters for Detergent and Rinse.

Detergent

Detergent settings for Probeless Mode on an Alternate (Alt) Door Machine require the following fields to be set:

Initial Charge (0-200s): An initial charge is meant to be dispensed every time the tank is drained and refilled with fresh water. In Probeless, Alternate (Alt) Door Mode, it is triggered when the detergent signal is received and stays on for 10 seconds. The detergent signal in this case should be wired to a signal that is on once per drain/fill cycle such as an “on light,” the on/off switch on the dish machine, or if present, or an electrical tank heat circuit between the tank heater switch and the thermostat. If the dish machine does not have the appropriate signals, please contact Hydro Technical Support.

Incremental Dose (0-20s): An incremental dose is dispensed in Probeless, Alt Door Mode after racks complete and are counted (per the Rinse signal cycling on/off). The incremental dose will dispense for the time setting, and the pump will stop. To trigger another incremental dose, the proper number of racks must be completed.

Dose Interval (Every 1-3 Racks): In some cases on Alternate Door machine, the user may not want to inject detergent on every rack. If that is the case, the Dose Interval can be increased to dispense every 2 or 3 racks instead.

Calibrate Pump / Solenoid

Pump or solenoid calibration for Probeless Alternate (Alt) Door Mode is done identically to the process described starting on page 14.

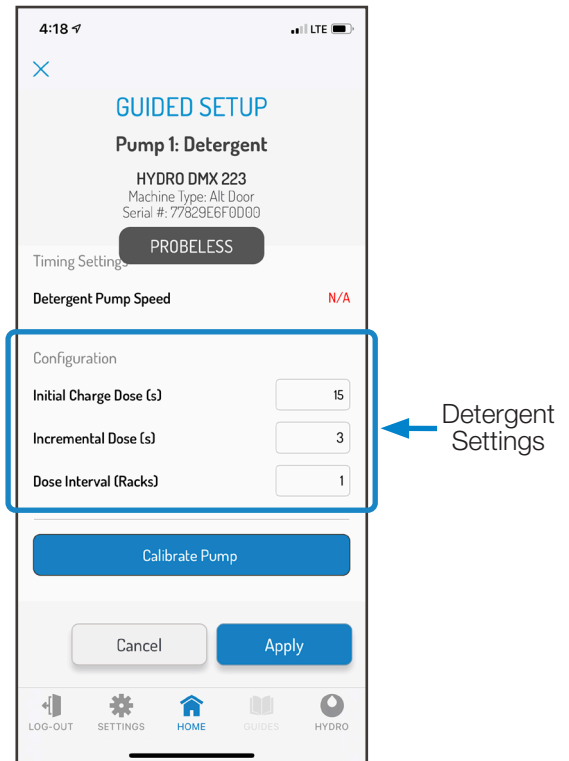
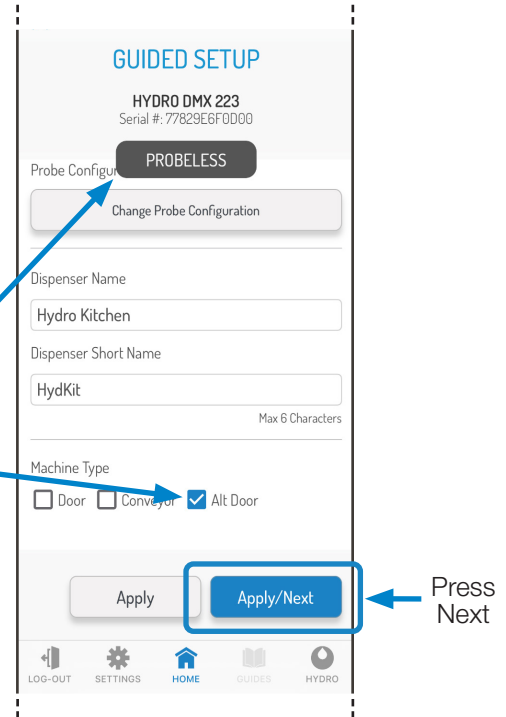

GUIDED SETUP - Probeless Mode (continued)

Probeless Mode on an Alternate (Alt) Door Machine (continued)

Rinse

1) To set up the rinse dispensing parameters for a unit operating in **Probeless Mode** on an **Alternate (Alt) Door Machine**, scroll to the top and select the **Rinse Pump**.

2) Next, enter the following:

- **Rinse Aid Pump Speed (5-55 RPM):** This is the speed that the pump will run at whenever the rinse signal is active.
- **Rinse Aid Time Delay (0-30s):** This is the amount of time that the rinse signal needs to be active before the rinse pump will begin dispensing.
- **Rinse Aid Feed Option:**
 - Rinse on Rinse- The rinse pump will run whenever the rinse signal is active as per the above configuration parameters.

NOTE: Alternate Door machine setups utilize the Rinse Saver feature that prevents the rinse pump from running more than 20 seconds per rack.

Sanitizer (3-Product Models Only)

1) To set up the sanitizer dispensing parameters for a unit operating in **Probeless Mode** on a **Alternate Door Machine**, scroll to the top and select the **Sanitizer Pump**.

2) Next, enter the following:

Sanitizer Pump Speed (5-55 RPM): This is the speed that the pump will run at whenever the rinse signal is active.

Calibrate Pump / Solenoid

Pump or solenoid calibration for Probeless, Door Mode is done identically to the process described starting on page 14.

When all settings for Detergent and Rinse have been set, press Apply to complete the Guided Setup.

ADVANCED SETUP

Asset Management

For purposes of reporting to Hydro Connect, it is critical that the DMx dispenser gets linked to a valid site that is set up within Hydro Connect.

This will allow the data to stream to Hydro Connect but will also provide valuable information regarding where the dispenser is physically located and when it was installed.

To make this link, press the Asset Management button to produce a list of all the valid sites that are setup within the user's Chemical Company hierarchy in Hydro Connect.

Search using the search bar for the site in which the DMx is being installed and press Apply.

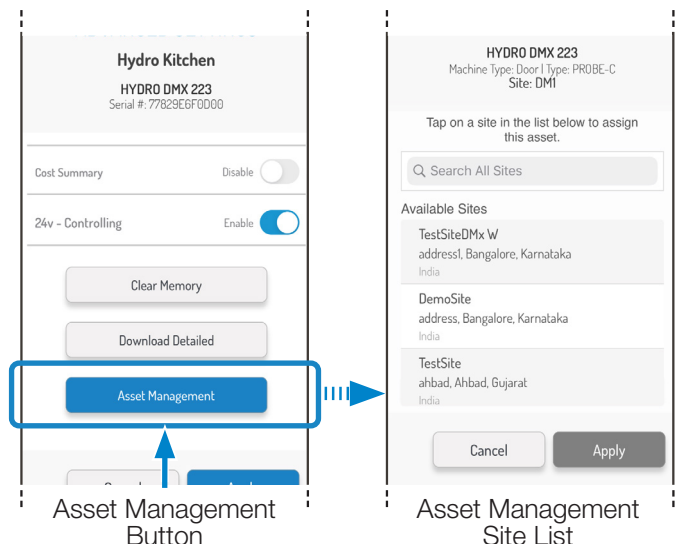
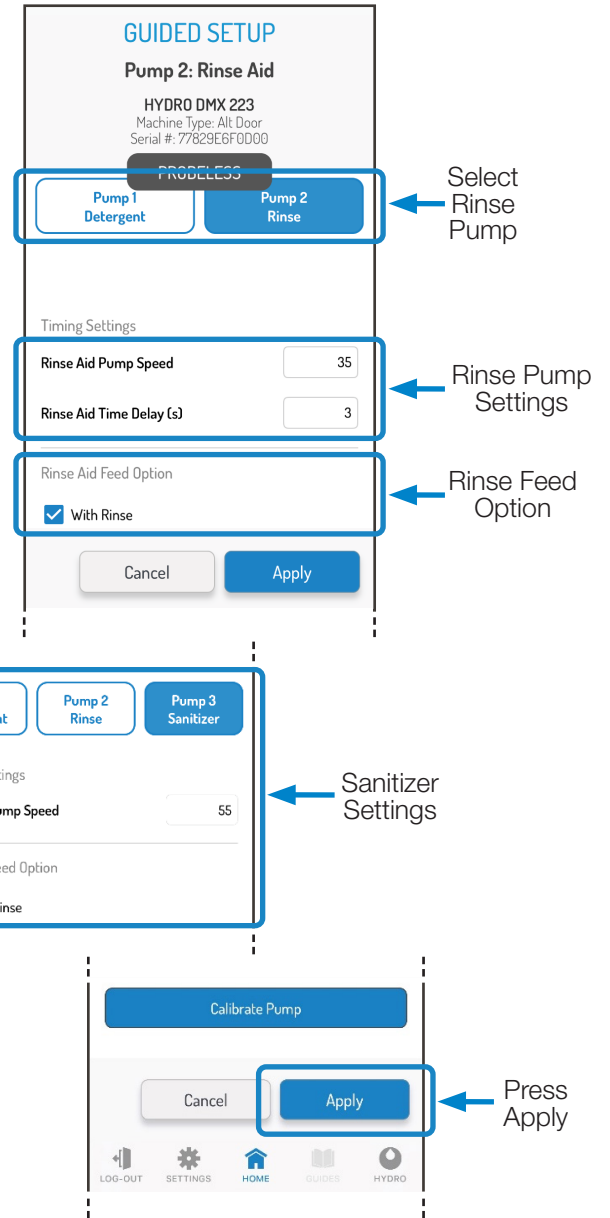

maintenance



WARNING: Before you perform the below maintenance, disconnect the incoming power source or press the Power/Standby button to prevent the dispenser from running.

Routine Maintenance

- If installed, check the conductivity probe, tank temperature sensor, and rinse temperature sensor for scale or other deposit build up. Clean as necessary.
- Titrate the wash tank solution to verify that the unit is holding accurate concentration.
- If using solid chemistry, keep the solenoid connections free from scale and other deposit build up.
- Check squeeze tube condition and replace, if needed. (Only applicable to peristaltic models).
- Check all connections between the chemical drums, the dispenser, and the dish machine for leaks.
- Check all cables and electrical connections for damaged wires. Repair or replace as needed.
- Keep the unit cabinet clean. Wipe with a damp cloth as necessary.
- Check the dispenser LEDs to see if there are any alarms present. Address any alarm conditions as indicated. (See the full DMx dispenser manual for more details about alarm conditions.) Common maintenance alarms are:
 - Change a squeeze tube
 - Change tank water
 - Delime the tank on the dish machine

Squeeze Tube Replacement



WARNING: Before you change squeeze tubes, disconnect the incoming power source!

Replace the pump squeeze tubes at regular maintenance intervals to avoid the negative impacts of tube wear. These include, chemical delivery volume decline or in extreme cases, tube rupture. If the tube does rupture, clean all product from the pump with a damp cloth.

- 1) Remove the main cabinet cover.
- 2) Loosen the pump front captive screw and remove the pump front cover.
- 3) Remove the old tube with the compression-style fittings.
- 4) Install the new tube, oriented with flat sides facing towards the front.
- 5) Do not lubricate the squeeze tube or spinner roller. Maximum delivery volume and accuracy requires clean, dry surfaces.
- 6) Insert new tube from left side of pump, with pump spinner oriented between an 11 to 1 o'clock position.
- 7) Slowly turn the spinner clockwise, using your hand as you position the tube into place, midway on the roller. The tube must also be evenly distributed on either side of the spinner.

Change Tank Water

- 1) Press the Power/Standby button to prevent the dispenser from running while performing maintenance.
- 2) Follow the dish machine manufacturer's procedure for draining and refilling the detergent tank.

Delime the Tank

- 1) Press the Power/Standby button to prevent the dispenser from running while performing maintenance.
- 2) Follow the dish machine manufacturer's procedure for delimiting the dish machine.

warranty

Limited Warranty

Seller warrants solely to **Buyer** the Products will be free from defects in material and workmanship under normal use and service for a period of one year from the date of completion of manufacture. This limited warranty does not apply to (a) hoses; (b) and products that have a normal life shorter than one year; or (c) failure in performance or damage caused by chemicals, abrasive materials, corrosion, lightning, improper voltage supply, physical abuse, mishandling or misapplication. In the event the Products are altered or repaired by **Buyer** without **Seller's** prior written approval, all warranties will be void.

No other warranty, oral, express or implied, including any warranty of merchantability or fitness for any particular purpose, is made for these products, and all other warranties are hereby expressly excluded.

Seller's sole obligation under this warranty will be, at **Seller's** option, to repair or replace F.O.B. **Seller's** facility in Cincinnati, Ohio any Products found to be other than as warranted.

Limitation of Liability

Seller's warranty obligations and **Buyer's** remedies are solely and exclusively as stated herein. **Seller** shall have no other liability, direct or indirect, of any kind, including liability for special, incidental, or consequential damages or for any other claims for damage or loss resulting from any cause whatsoever, whether based on negligence, strict liability, breach of contract or breach of warranty.



Hydro Systems
3798 Round Bottom Road
Cincinnati, OH 45244 USA

Phone 513.271.8800
Toll Free 800.543.7184 (USA)
Fax 513.271.0160
Web hydrosystemsco.com

HYD10099867 Rev A 06/21